

LQA10T150C, LQA10N150C

Qspeed™ 产品系列

150 V/10 A共阴极二极管

产品概览

$I_{F(AVG)}$ (每个二极管)	5	A
V_{RRM}	150	V
Q_{RR} (125 °C下典型值)	21.4	nC
I_{RRM} (125 °C下典型值)	1.41	A
软度 t_b/t_a (125 °C下典型值)	0.59	

引脚分配

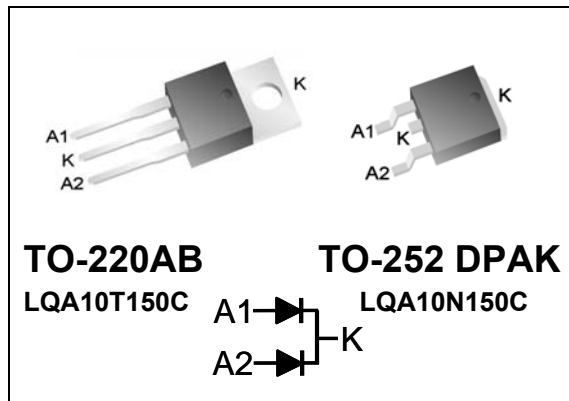

符合RoHS标准

封装采用无铅电镀和符合IEC 61249-2-21指令的“绿色环保”无卤模封料。

概述

该器件在所有150 V硅二极管中具有最低的 Q_{RR} 。其恢复特性能提高效率、降低EMI并省去缓冲电路。

应用

- AC/DC和DC/DC输出整流
 - 输出和续流二极管
- 电机驱动电路
- DC-AC逆变器

特性

- 低 Q_{RR} 、低 I_{RRM} 、低 t_{RR}
- 可实现高 di_F/dt 值
- 软恢复

优势

- 提高了效率
 - 无需缓冲电路
 - 缩减EMI滤波元件的尺寸和数目
- 实现极快速开关

绝对最大额定值

绝对最大额定值是指一旦超过就可能使器件受损或缩短其使用寿命的极限值。不建议在此类条件下进行工作操作。

符号	参数	条件	额定值	单位
V_{RRM}	峰值重复反向电压	$T_J = 25\text{ °C}$	150	V
$I_{F(AVG)}$	平均前馈电流	每个二极管, $T_J = 150\text{ °C}$, $T_C = 130\text{ °C}$	5	A
		每个器件, $T_J = 150\text{ °C}$, $T_C = 130\text{ °C}$	10	A
I_{FSM}	非重复峰值浪涌电流	每个二极管, 60 Hz, ½周期	60	A
I_{FSM}	非重复峰值浪涌电流	每个二极管, $t = 28\text{ }\mu\text{s}$ 正弦的½周期, $T_C = 25\text{ °C}$	350	A
T_J	工作结温范围		-55至150	°C
T_{STG}	贮存温度		-55至150	°C
	引线焊接温度	引线距壳体1.6mm, 10秒	300	°C
P_D	功耗	$T_C = 25\text{ °C}$	27.7	W

热阻

符号	电阻来自:	条件	额定值	单位
$R_{\theta JA}$	结到环境	TO-220AB (仅)	62	°C/W
$R_{\theta JC}$	结到壳体	每个二极管	4.5	°C/W
		每个器件	2.3	°C/W

电气规格, $T_J = 25\text{ }^\circ\text{C}$ (除非另有指定)

符号	参数	条件	最小值	典型值	最大值	单位	
每个二极管的DC特性							
I_R	每个二极管的反向电流	$V_R = 150\text{ V}, T_J = 25\text{ }^\circ\text{C}$	-	-	250	μA	
		$V_R = 150\text{ V}, T_J = 125\text{ }^\circ\text{C}$	-	0.1	-	mA	
V_F	每个二极管的正向电压	$I_F = 5\text{ A}, T_J = 25\text{ }^\circ\text{C}$	-	0.95	1.1	V	
		$I_F = 5\text{ A}, T_J = 150\text{ }^\circ\text{C}$	-	0.8	-	V	
C_J	每个二极管的结电容	$V_R = 10\text{ V}, 1\text{ MHz}$	-	22	-	pF	
每个二极管的动态特性							
t_{RR}	每个二极管的反向恢复时间	$dI_F/dt = 100\text{ A}/\mu\text{s}$ $V_R = 100\text{ V},$ $I_F = 5\text{ A}$	$T_J = 25\text{ }^\circ\text{C}$	-	15.1	-	ns
			$T_J = 125\text{ }^\circ\text{C}$	-	23.6	-	ns
Q_{RR}	每个二极管的反向恢复电荷	$dI_F/dt = 100\text{ A}/\mu\text{s}$ $V_R = 100\text{ V},$ $I_F = 5\text{ A}$	$T_J = 25\text{ }^\circ\text{C}$	-	8.6	21.3	nC
			$T_J = 125\text{ }^\circ\text{C}$	-	21.4	-	nC
I_{RRM}	每个二极管的最大反向恢复电流	$dI_F/dt = 100\text{ A}/\mu\text{s}$ $V_R = 100\text{ V},$ $I_F = 5\text{ A}$	$T_J = 25\text{ }^\circ\text{C}$	-	0.92	2.06	A
			$T_J = 125\text{ }^\circ\text{C}$	-	1.41	-	A
S	每个二极管的软度 = $\frac{t_b}{t_a}$	$dI_F/dt = 100\text{ A}/\mu\text{s}$ $V_R = 100\text{ V},$ $I_F = 5\text{ A}$	$T_J = 25\text{ }^\circ\text{C}$	-	0.69	-	
			$T_J = 125\text{ }^\circ\text{C}$	-	0.59	-	

元件工程师请注意: Q系列二极管的设计和结构采用肖特基技术。因此, 元件工程师应规划其测试装置, 使其与传统的肖特基测试装置类似。(详细信息请参考应用指南AN-300。)



图1. 反向恢复定义



图2. 反向恢复测试电路

电气规格, $T_J = 25\text{ }^\circ\text{C}$ (除非另有指定)

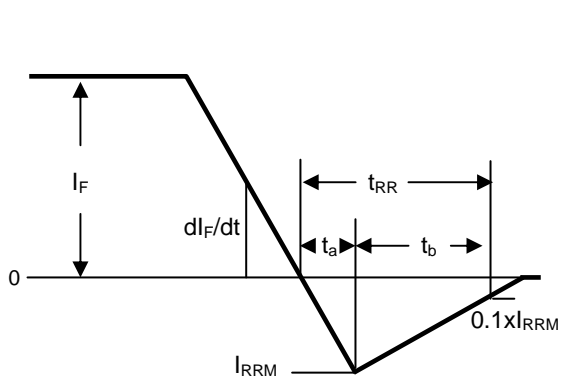

图3. 典型 I_F 与 V_F 比较

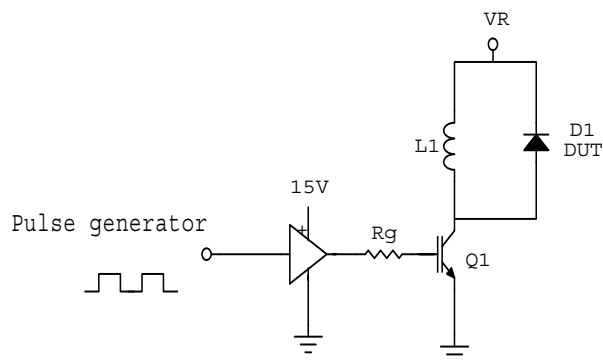

图4. 典型 I_F 与 V_F 比较

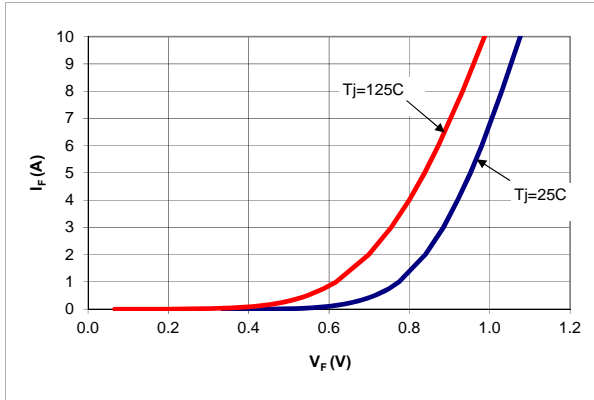

图5. 典型 C_j 与 V_R 比较

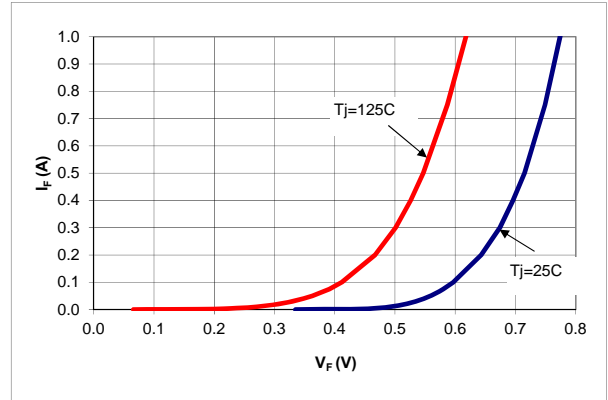

图6. DC电流降额曲线

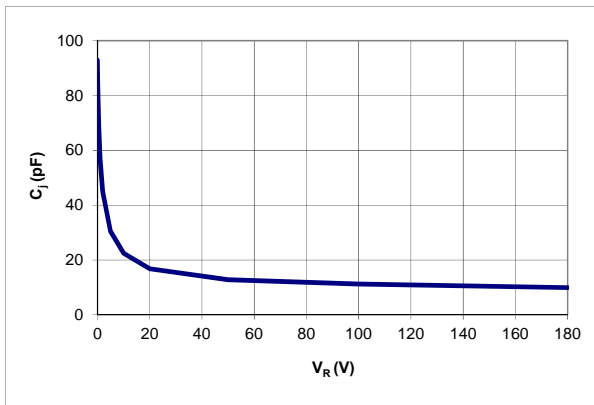

图7. 典型 Q_{RR} 与 I_F 比较, $T_J = 125\text{ }^\circ\text{C}$

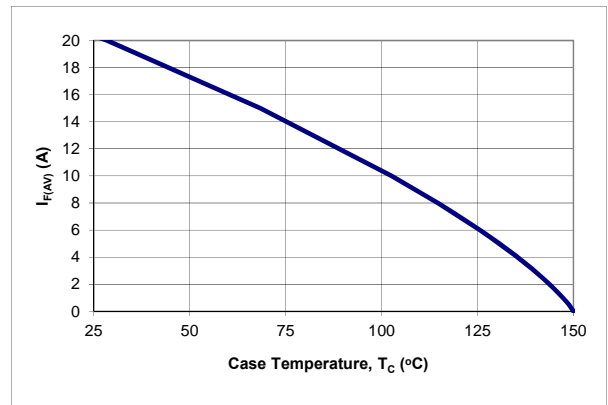

图8. 典型 t_{RR} 与 I_F 比较, $T_J = 125\text{ }^\circ\text{C}$

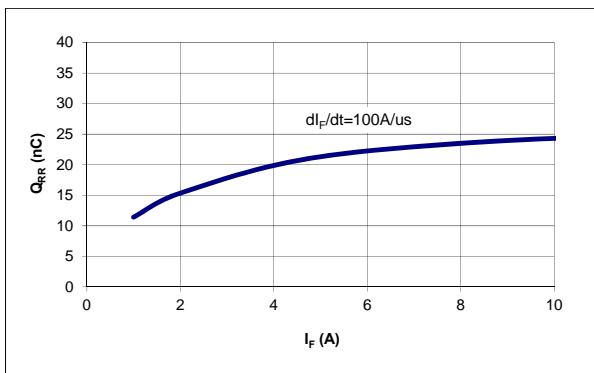

图9. 功率降额曲线

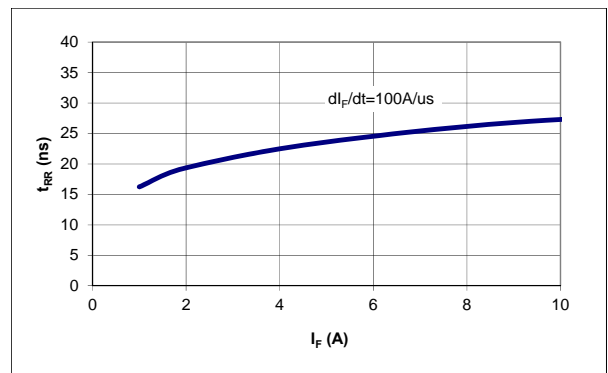

图10. IF (Peak)与TC比较. f = 70 kHz

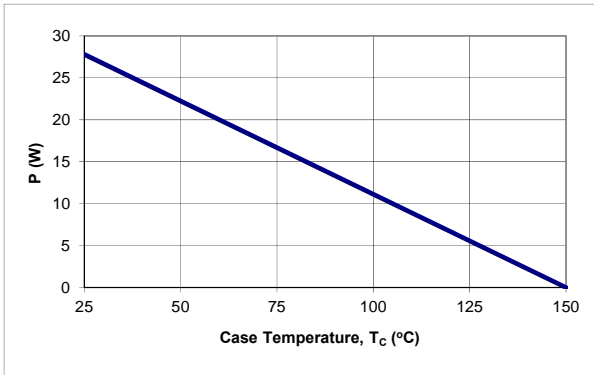

图11. 归一化最大瞬态热阻抗

外形尺寸图

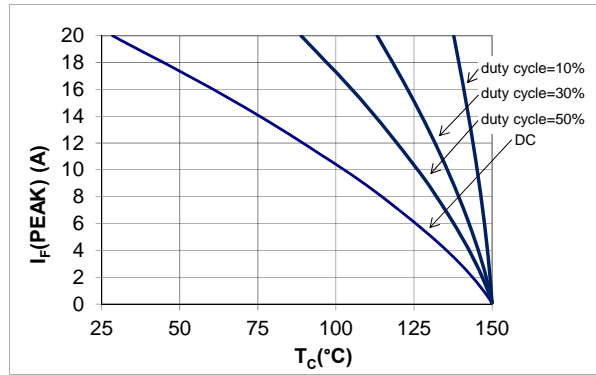
TO-220AB

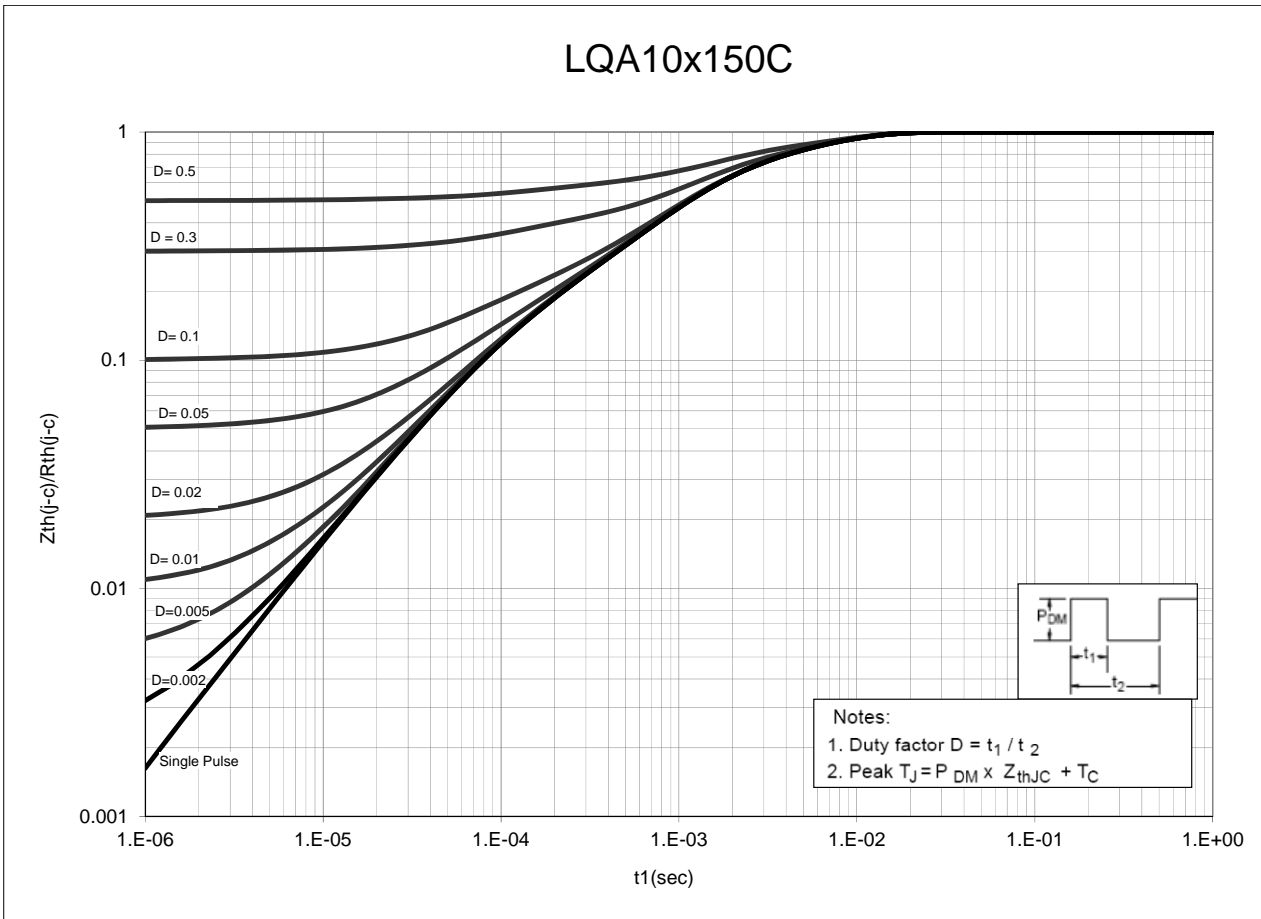
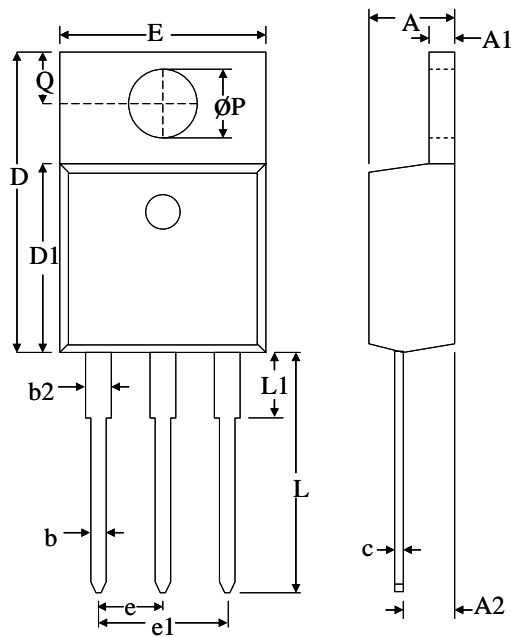

尺寸	毫米	
	最小值	最大值
A	4.32	4.70
A1	1.11	1.38
A2	2.59	2.79
b	0.77	1.00
b2	1.23	1.36
C	0.34	0.47
D	14.71	15.75
D1	9.05	9.25
E	9.96	10.36
e	2.44	2.64
e1	4.98	5.18
L	12.70	14.22
L1	-	3.90
$\varnothing P$	3.71	3.96
Q	2.54	2.90

机械安装方法	最大扭矩/压力规格
螺丝穿过封装片中的孔	1牛米(nm)或8.8英寸磅(lb-in)
夹住封装体	每平方米12.3千克力(kgf/cm ²)或175 lbf/in ²

TO-252 DPAK

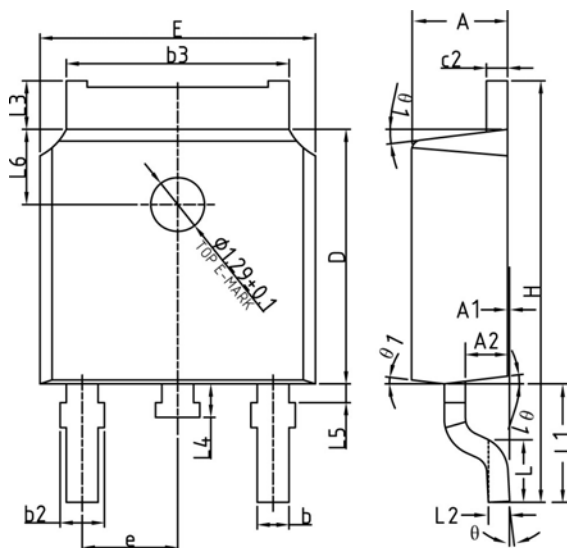

尺寸	毫米	
	最小值	最大值
A	2.20	2.38
A1	0	0.10
A2	0.90	1.10
b	0.72	0.85
b2	0.72	0.90
b3	5.13	5.46
c2	0.47	0.60
D	6.00	6.20
E	6.50	6.70
e	2.186	2.386
H	9.80	10.40
L	1.40	1.70
L1	2.90 REF	
L2	0.51 BSC	
L3	0.90	1.25
L4	0.60	1.00
L5	0.15	0.75
L6	1.80 REF	
\varnothing	0°	8°
$\varnothing 1$	5°	9°

焊接时间和温度：本产品经设计可用于高温、无铅焊接。元件引线可持续10秒承受300 °C的最高温度。详细信息请参考应用指南AN-303。

元件订购信息

元件编号	封装	包装
LQA10T150C	TO-220AB	50件/管
LQA10N150C	TO-252 DPAK	2500件/卷

本档所提供的信息可能会发生变更，恕不另行通知。

修订版本	注释	日期
1.0	初始版本	12/14

有关最新产品信息，请访问：www.powerint.com

Power Integrations reserves the right to make changes to its products at any time to improve reliability or manufacturability. Power Integrations does not assume any liability arising from the use of any device or circuit described herein. POWER INTEGRATIONS MAKES NO WARRANTY HEREIN AND SPECIFICALLY DISCLAIMS ALL WARRANTIES INCLUDING, WITHOUT LIMITATION, THE IMPLIED WARRANTIES OF MERCHANTABILITY, FITNESS FOR A PARTICULAR PURPOSE, AND NON-INFRINGEMENT OF THIRD PARTY RIGHTS.

PATENT INFORMATION

The products and applications illustrated herein (including transformer construction and circuits' external to the products) may be covered by one or more U.S. and foreign patents, or potentially by pending U.S. and foreign patent applications assigned to Power Integrations. A complete list of Power Integrations' patents may be found at www.powerint.com. Power Integrations grants its customers a license under certain patent rights as set forth at <http://www.powerint.com/ip.htm>.

The PI Logo, TOPSwitch, TinySwitch, LinkSwitch, LYTSwitch, DPA-Switch, PeakSwitch, CAPZero, SENZero, LinkZero, HiperPFS, HiperTFS, HiperLCS, Qspeed, EcoSmart, Clampless, E-Shield, Filterfuse, StackFET, PI Expert and PI FACTS are trademarks of Power Integrations, Inc. Other trademarks are property of their respective companies. ©Copyright 2013 Power Integrations, Inc.

Power Integrations全球销售支持网络

全球总部

5245 Hellyer Avenue
San Jose, CA 95138, USA.
Main: +1-408-414-9200
Customer Service:
Phone: +1-408-414-9665
Fax: +1-408-414-9765
e-mail: usasales@powerint.com

德国

Lindwurmstrasse 114
80337, Munich
Germany
Phone: +49-895-527-39110
Fax: +49-895-527-39200
e-mail: eurosales@powerint.com

日本

Kosei Dai-3 Building
2-12-11, Shin-Yokohama,
Kohoku-ku, Yokohama-shi,
Kanagawa 222-0033
Japan
Phone: +81-45-471-1021
Fax: +81-45-471-3717
e-mail: japansales@powerint.com

台湾

5F, No. 318, Nei Hu Rd.,
Sec. 1
Nei Hu District
Taipei 11493, Taiwan R.O.C.
Phone: +886-2-2659-4570
Fax: +886-2-2659-4550
e-mail: taiwansales@powerint.com

中国（上海）

Rm 2410, Charity Plaza, No. 88,
North Caoxi Road,
Shanghai, PRC 200030
Phone: +86-21-6354-6323
Fax: +86-21-6354-6325
e-mail: chinasales@powerint.com

印度

#1, 14th Main Road
Vasanthanagar
Bangalore-560052
India
Phone: +91-80-4113-8020
Fax: +91-80-4113-8023
e-mail: indiasales@powerint.com

韩国

RM 602, 6FL
Korea City Air Terminal B/D,
159-6
Samsung-Dong, Kangnam-Gu,
Seoul, 135-728 Korea
Phone: +82-2-2016-6610
Fax: +82-2-2016-6630
e-mail: koreasales@powerint.com

欧洲总部

1st Floor, St. James's House
East Street, Farnham
Surrey GU9 7TJ
United Kingdom
Phone: +44 (0) 1252-730-141
Fax: +44 (0) 1252-727-689
e-mail: eurosales@powerint.com

中国（深圳）

3rd Floor, Block A,
Zhongtuo International Business
Center, No. 1061, Xiang Mei Rd,
FuTian District, ShenZhen,
China, 518040
Phone: +86-755-8379-3243
Fax: +86-755-8379-5828
e-mail: chinasales@powerint.com

意大利

Via Milanese 20, 3rd Fl.
20099 Sesto San Giovanni
(MI) Italy
Phone: +39-024-550-8701
Fax: +39-028-928-6009
e-mail: eurosales@powerint.com

新加坡

51 Newton Road,
#19-01/05 Goldhill Plaza
Singapore, 308900
Phone: +65-6358-2160
Fax: +65-6358-2015
e-mail: singaporesales@powerint.com

技术支持热线

World Wide +1-408-414-9660

技术支持传真

World Wide +1-408-414-9760