Design Example Report

Title	<i>125 W 2-Stage Boost and Isolated Flyback Dimmable LED Ballast Using HiperPFS™-4 PFS7628C and LYTSwitch™-6 GaN-based LYT6070C</i>
Specification	100 VAC – 277 VAC Input; 42 V, 3000 mA Output
Application	3-Way Dimming LED Ballast
Author	Applications Engineering Department
Document Number	DER-901
Date	March 31, 2020
Revision	1.0

Summary and Features

- With integrated PFC function, PF >0.95, <10% ATHD
- Accurate output voltage and current regulation, ±5%
- Very low ripple current, <10% of I_{OUT}
- Highly energy efficient, 90 % at 230 V
- Low cost and low component count for compact PCB solution
- 3-way dimming functions
 - 0 VDC - 10 VDC analog dimming
 - 10 V PWM signal (frequency range: 100 Hz to 3 kHz)
 - Variable resistance (0 to 100 kΩ)
- Integrated protection and reliability features
 - Output short-circuit
 - Line and output OVP
 - Line surge or line overvoltage
 - Over temperature shutdown with hysteretic automatic power recovery
- No damage during line brown-out or brown-in conditions
- Meets IEC 2.5 kV ring wave, 1 kV differential surge
- Meets EN55015 conducted EMI

Power Integrations

5245 Hellyer Avenue, San Jose, CA 95138 USA.
Tel: +1 408 414 9200 Fax: +1 408 414 9201
www.power.com

PATENT INFORMATION

The products and applications illustrated herein (including transformer construction and circuits external to the products) may be covered by one or more U.S. and foreign patents, or potentially by pending U.S. and foreign patent applications assigned to Power Integrations. A complete list of Power Integrations' patents may be found at www.power.com. Power Integrations grants its customers a license under certain patent rights as set forth at <https://www.power.com/company/intellectual-property-licensing/>.



Table of Contents

1	Introduction.....	6
2	Power Supply Specification	8
3	Schematic.....	9
4	Circuit Description.....	13
4.1	Input EMI Filter and Rectifier.....	13
4.2	First Stage: Boost PFC Using HiperPFS-4.....	14
4.2.1	Input Feed Forward Sense Circuit	16
4.2.2	PFC Output Feedback.....	16
4.2.3	Bias Supply Series Regulator.....	16
4.3	Second Stage: Isolated Flyback DC-DC Using LYTSwitch-6	17
4.4	3-Way Dimming Control Circuit.....	20
4.4.1	0 VDC – 10 VDC Dimming	21
4.4.2	Variable Duty PWM Input (10 V Peak)	21
4.4.3	Variable Resistance (0 Ω – 100 k Ω)	21
5	PCB Layout.....	22
6	Bill of Materials	23
6.1	Main BOM	23
6.2	Miscellaneous Parts.....	25
7	PFC Inductor Specification (T4).....	26
7.1	Electrical Diagram.....	26
7.2	Electrical Specifications	26
7.3	Material List	26
7.4	PFC Inductor Build Diagram (T4)	27
7.5	PFC Inductor Construction (T4)	27
7.6	Winding Illustrations	28
8	Transformer Specification (T3).....	30
8.1	Electrical Diagram.....	30
8.2	Electrical Specifications	30
8.3	Material List	30
8.4	Transformer Build Diagram (T3)	31
8.5	Transformer Construction (T3)	31
8.6	Winding Illustrations	32
9	Design Spreadsheet	36
9.1	HiperPFS-4 Design Spreadsheet.....	36
9.2	LYTSwitch-6 Design Spreadsheet.....	41
10	Heat Sink Assembly.....	44
10.1	Heat Sink Fabrication Drawing.....	44
10.2	Heat Sink Fabrication Drawing.....	45
10.3	Heat Sink and Assembly Drawing.....	46
11	Performance Data	47
11.1	CV/CC Output Characteristic Curve	47
11.2	System Efficiency.....	48
11.3	Output Current Regulation	49

11.4	Power Factor	50
11.5	%ATHD	51
11.6	Individual Harmonic Content at 42 V LED Load.....	52
11.7	No-Load Input Power	54
12	Test Data	55
12.1	42 V LED Load.....	55
12.2	39 V LED Load.....	55
12.3	36 V LED Load.....	56
12.4	33 V LED Load.....	56
12.5	No-Load	56
12.6	Individual Harmonic Content at 120 VAC and 42 V LED Load.....	57
12.7	Individual Harmonic Content at 230 VAC and 42 V LED Load.....	58
13	Dimming Performance.....	59
13.1	Dimming Curve.....	59
13.1.1	0 V - 10 V Dimming Curve	59
13.1.2	10 V 3 kHz to 300 Hz PWM Dimming Curve	61
13.1.3	Variable Resistor Dimming Curve	63
14	Thermal Performance.....	65
14.1	Thermal Scan at 25 °C Ambient.....	65
14.1.1	Thermal Scan at 100 VAC Full Load.....	66
14.2	Thermal Performance at 50 °C Ambient	67
15	Waveforms.....	68
15.1	Input Voltage and Input Current at 42 V LED Load	68
15.2	Start-up Profile at 42 V LED Load	69
15.3	Start-up Profile at 33 V LED Load	70
15.4	Output Current Fall at 42 V LED Load	71
15.5	Output Current Fall at 33 V LED Load	72
15.6	PFS7628C (U2) Drain Voltage and Current at Normal Operation	73
15.7	PFS7626C (U2) Drain Voltage and Current at Start-up	75
15.8	LYTSwitch-6 (U4) Drain Voltage and Current at Normal Operation	76
15.9	LYTSwitch-6 (U4) Drain Voltage and Current at Start-up.....	78
15.10	LYTSwitch-6 (U4) Drain Voltage and Current during Output Short-Circuit	79
15.11	Output Ripple Current at Full load.....	80
15.12	Output Ripple Current at 33 V LED Load	81
16	AC Cycling Test at 42 V LED Load	82
17	AC Cycling Test at 33 V LED Load	83
18	Conducted EMI	84
18.1	Test Set-up	84
18.2	Equipment and Load Used.....	84
18.2.1	EMI Test Results	85
19	Line Surge.....	87
19.1	Differential Surge Test Results.....	87
19.2	Ring Wave Test Results.....	87
20	Brown-in/Brown-out Test	88

21 Revision History 89

Important Note: Although this board is designed to satisfy safety isolation requirements, the engineering prototype has not been agency approved. Therefore, all testing should be performed using an isolation transformer to provide the AC input to the prototype board.



1 Introduction

This engineering report defines a 125 W LED ballast equipped with a 3-way dimming functionality. It is designed to provide a constant current output of 3000 mA to a 42 V LED load at full load. The 3-way dimming function is designed to vary the output current from 3000 mA down to 0 mA for a 42 V – 33 V LED voltage string. The design is optimized to operate from an input voltage range of 100 VAC to 277 VAC.

The key design goals were low component count, high power factor, low THD, and high efficiency. The document contains the power supply specification, schematic, bill of materials, transformer documentation, printed circuit layout, and performance data.

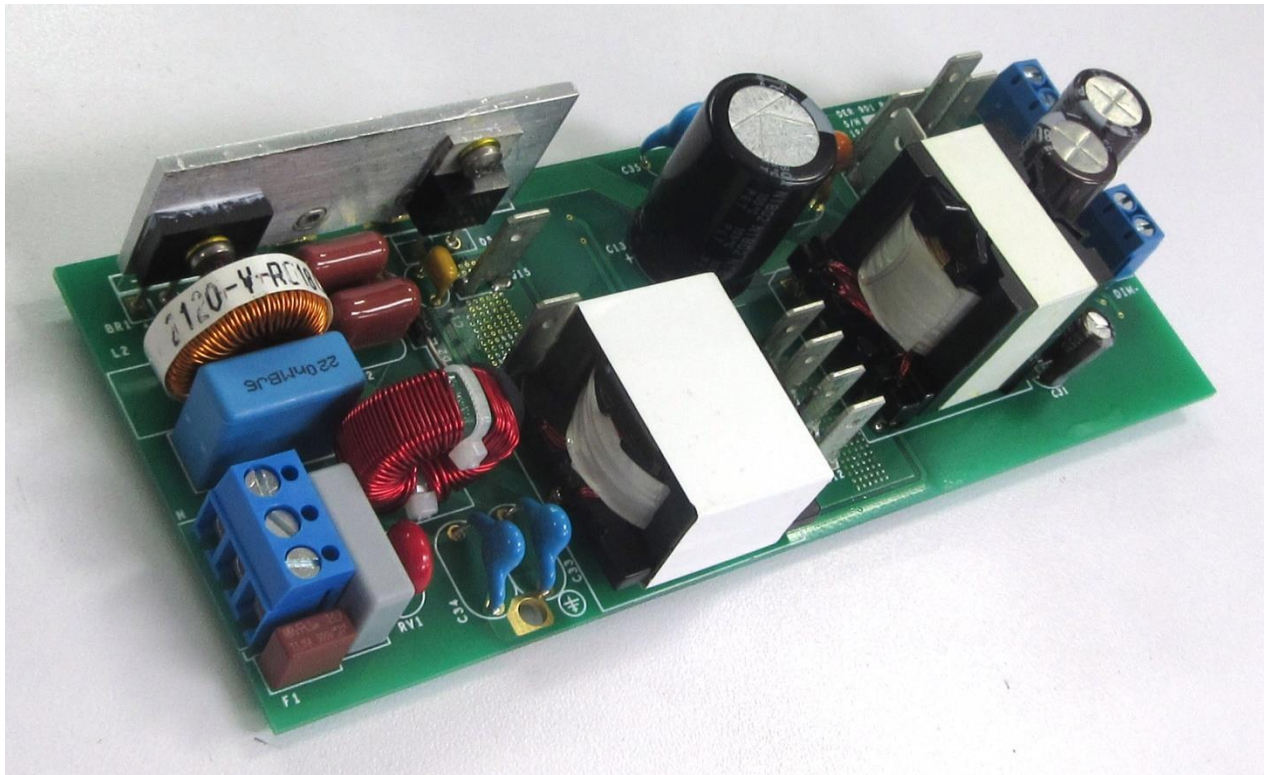

Figure 1 – Populated Circuit Board.

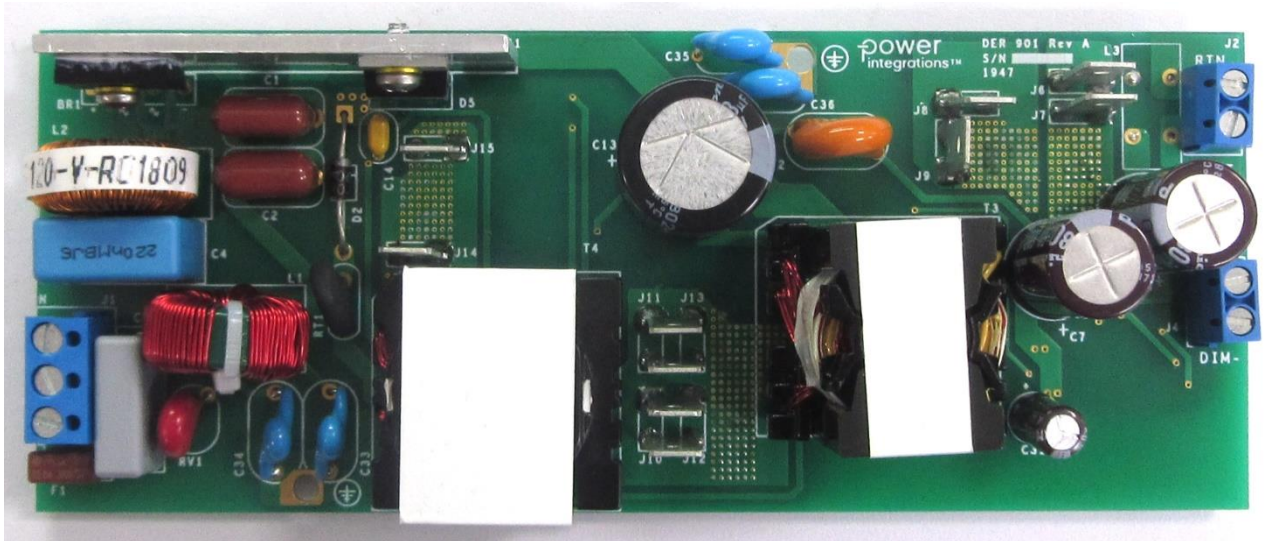

Figure 2 – Populated Circuit Board, Top View.

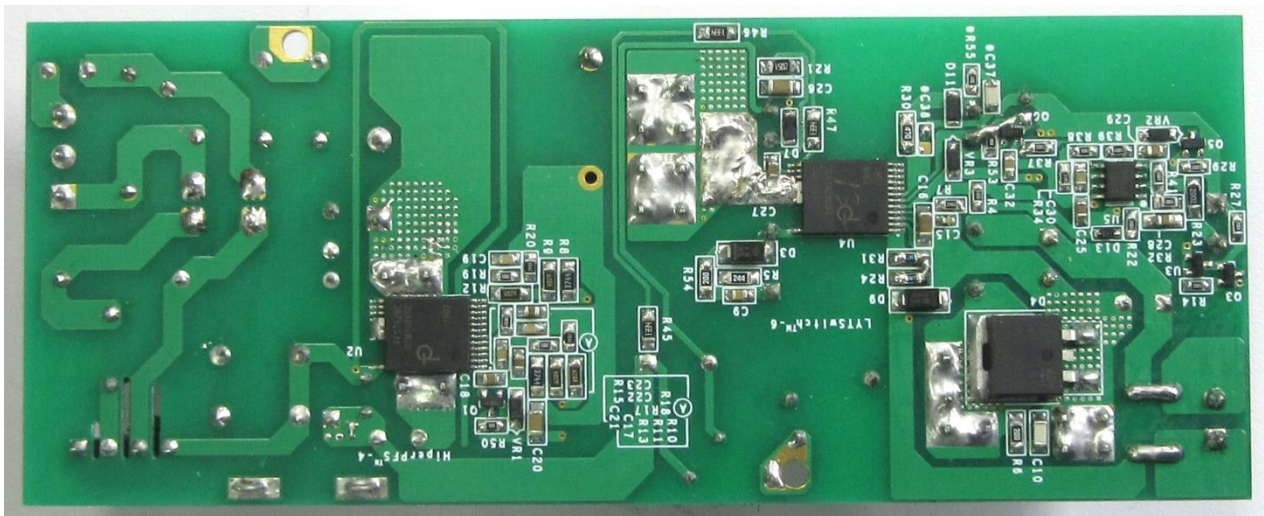

Figure 3 – Populated Circuit Board, Bottom View.

2 Power Supply Specification

The table below represents the minimum acceptable performance of the design. Actual performance is listed in the results section.

Description	Symbol	Min	Typ	Max	Units	Comment
Input						
Voltage	V_{IN}	100	120 / 60	277	VAC / Hz	2-Wire Floating Output or 3-Wire with P.E.
Frequency	f_{LINE}		230 / 50 277 / 60			
Output						
Output Voltage	V_{OUT}		42		V	±5%
Output Current	I_{OUT}	2850	3000	3150	mA	
Total Output Power						
Continuous Output Power	P_{OUT}		126		W	
Efficiency						
Full Load	η		90		%	120 V / 60 Hz at 25 °C.
Environmental						
Conducted EMI			CISPR 15B / EN55015B			
Safety			Isolated			
Ring Wave (100 kHz)			2.5		kV	
Differential Mode (L1-L2)			1.0		kV	
Power Factor			0.95			Measured at 115 V / 60 Hz, 230 VAC / 50 Hz and 277 V / 60 Hz.
ATHD			10		%	Measured at 120 V / 60 Hz, 230 VAC / 50 Hz and 277 V / 60 Hz.
Ambient Temperature	T_{AMB}		25	50	°C	Free Air Convection, Sea Level.

3 Schematic

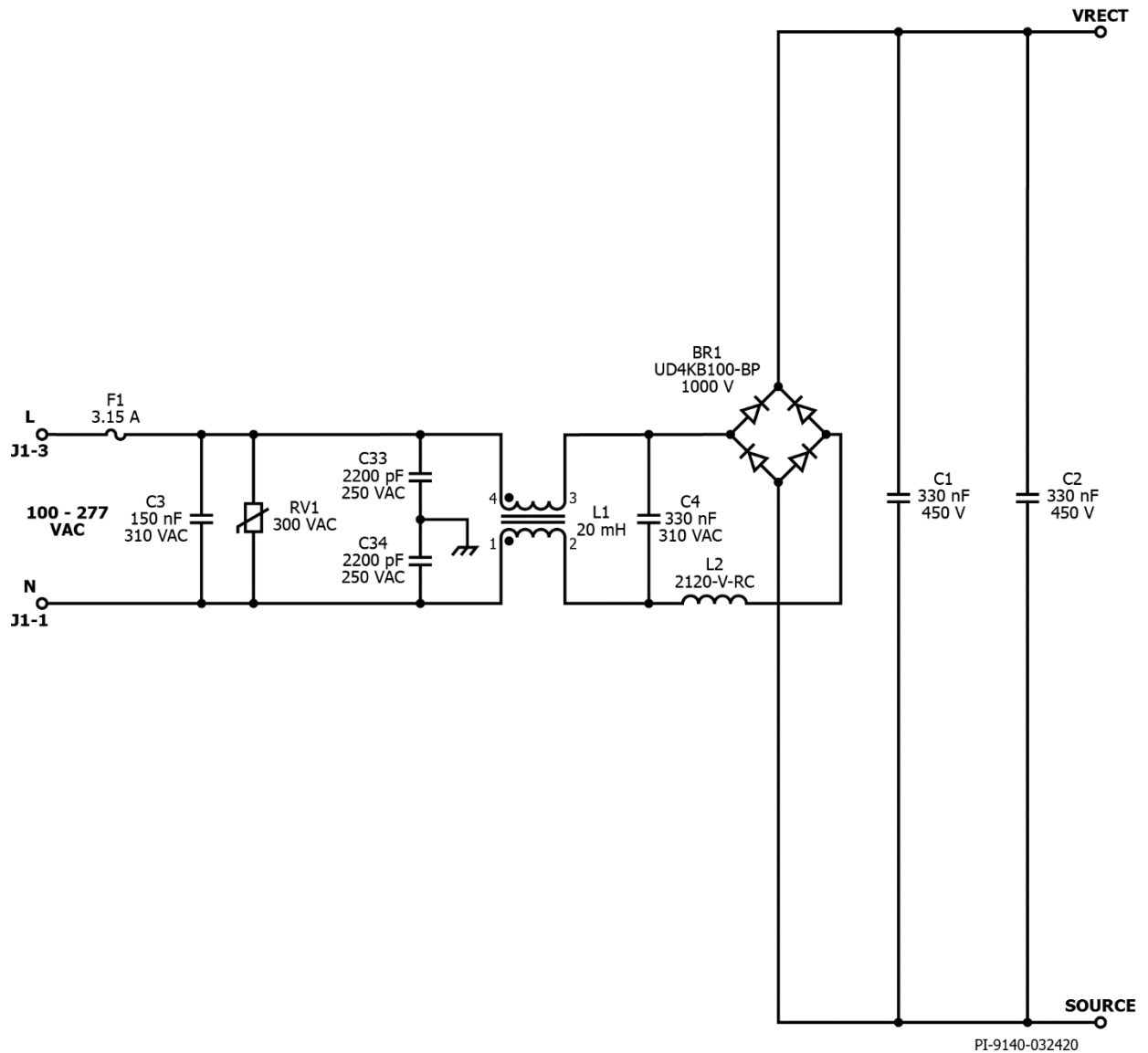
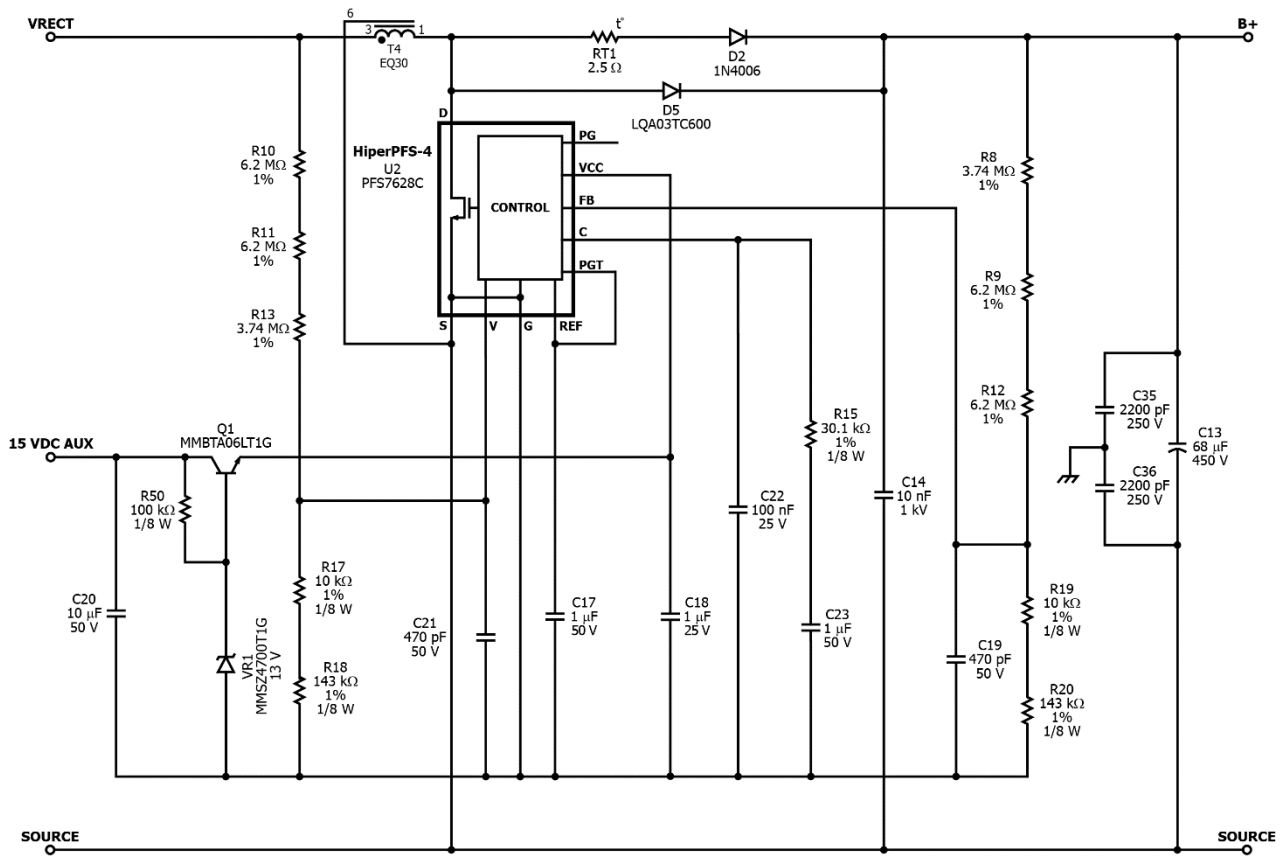

Figure 4 – Schematic, Input Section.





PI-9141-032420

Figure 5 – Schematic, PFC Section.



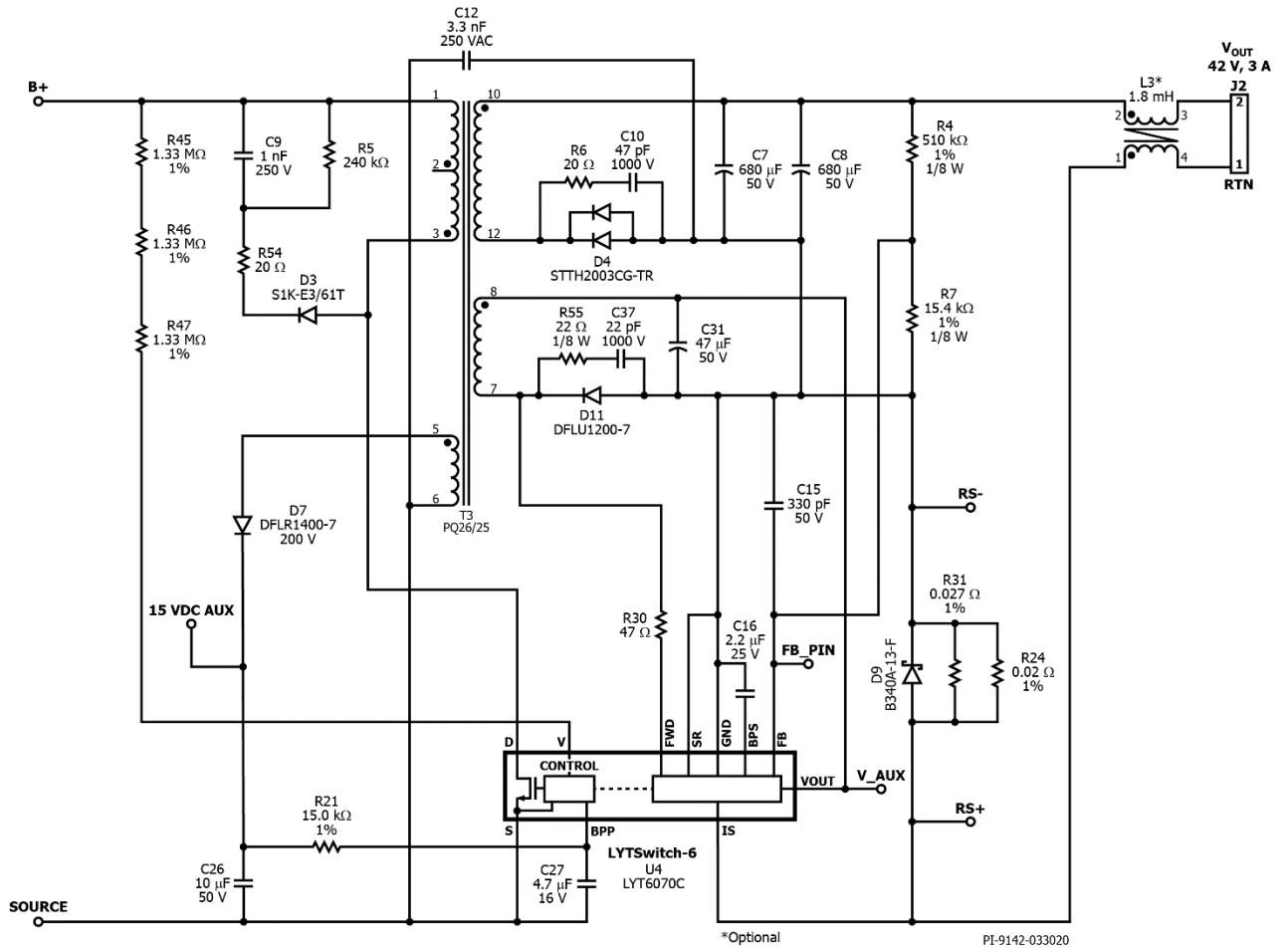

Figure 6 – Schematic, DC-DC Flyback Section.



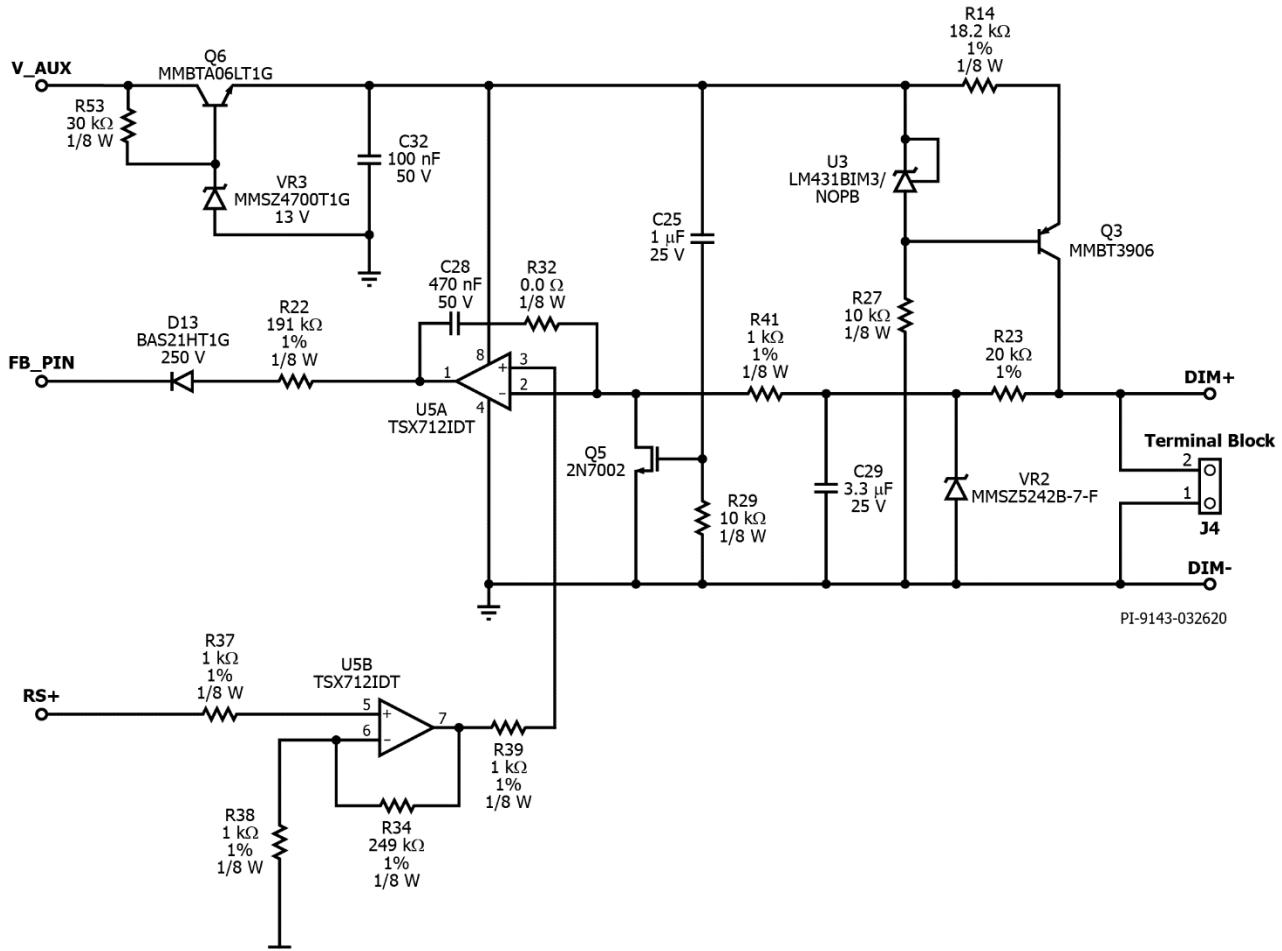

Figure 7 – Schematic, Dimming Section.

4 Circuit Description

The 125 W LED ballast uses two highly integrated devices to achieve high power factor, low THD, and efficient power conversion. The first stage is a PFC boost driver which utilizes PFS7628C from the HiperPFS-4 family. The second stage is an isolated flyback DC-DC power supply using LYT6070C from the LYTSwitch-6 family.

HiperPFS-4 PFS7628C is a continuous conduction mode (CCM) PFC controller with an integrated 600 V power MOSFET and gate driver. It is used to operate a power factor corrector stage at 410 V DC output voltage and a continuous power of 135 W from an input range of 100 VAC to 277 VAC.

LYTSwitch-6 devices integrate the primary FET, the primary-side control, and the secondary-side synchronous rectification control also in an InSOP-24D package. LYT6070C utilizes the FluxLink™ technology that safely bridges the isolation barrier and eliminates the use of an optocoupler.

4.1 *Input EMI Filter and Rectifier*

Input fuse F1 provides safety protection. Varistor RV1 acts as a voltage clamp by limiting the voltage spike on the primary during line transient voltage surge events. Bridge rectifier BR1 is used to rectify the AC input voltage in order to achieve high power factor and low THD.

Capacitors C1, C2, and C4 together with differential choke L2 form a Pi filter. This filter and C3 suppresses differential-mode noise. Common mode noise is suppressed by common mode choke L1 and Y capacitors C33 and C34. Another set of Y capacitors C35 and C36 across the bulk capacitor also helps in suppressing common mode noise.

4.2 **First Stage: Boost PFC Using HiperPFS-4**

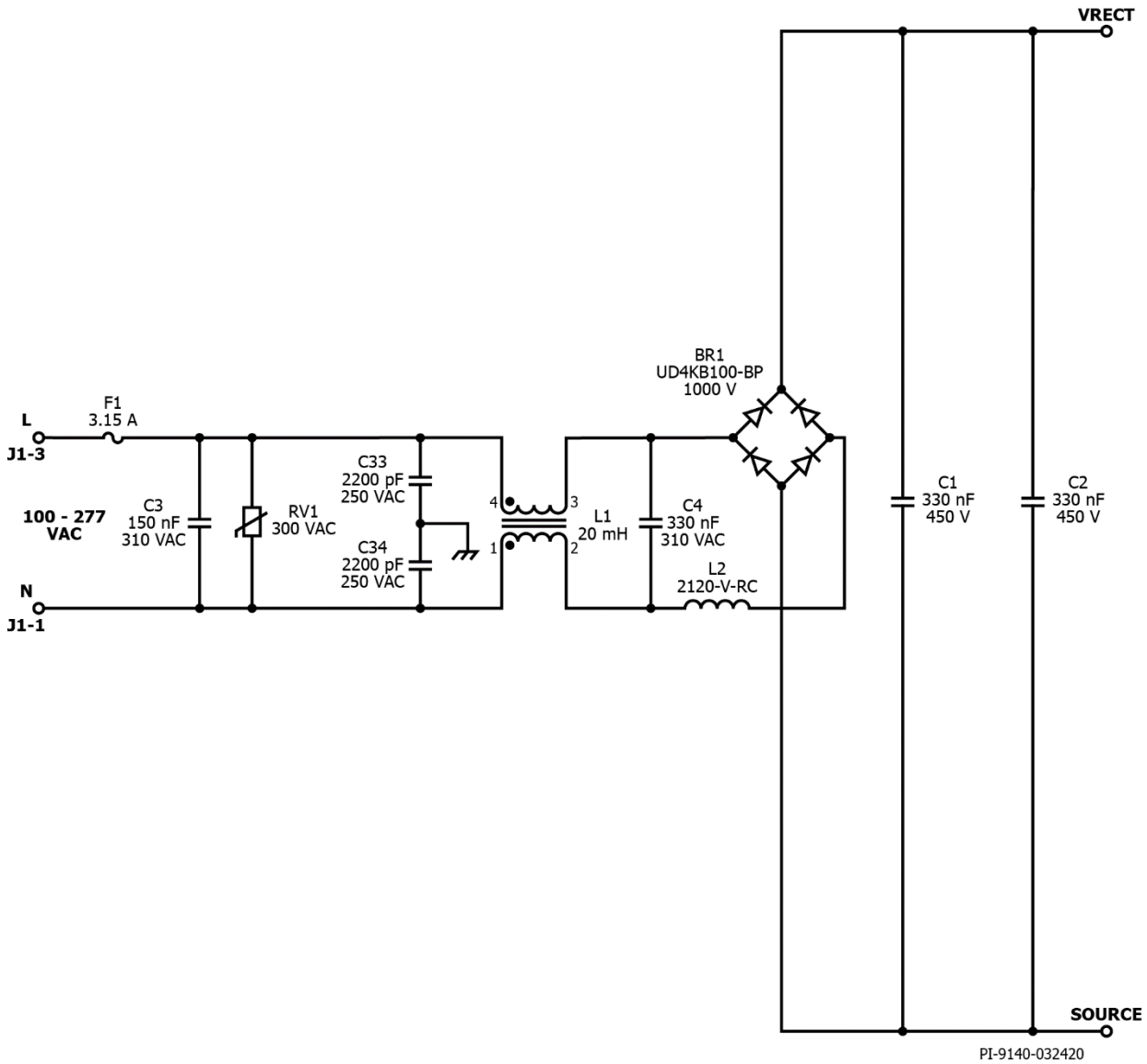

Figure 8 – Schematic, Input Section.

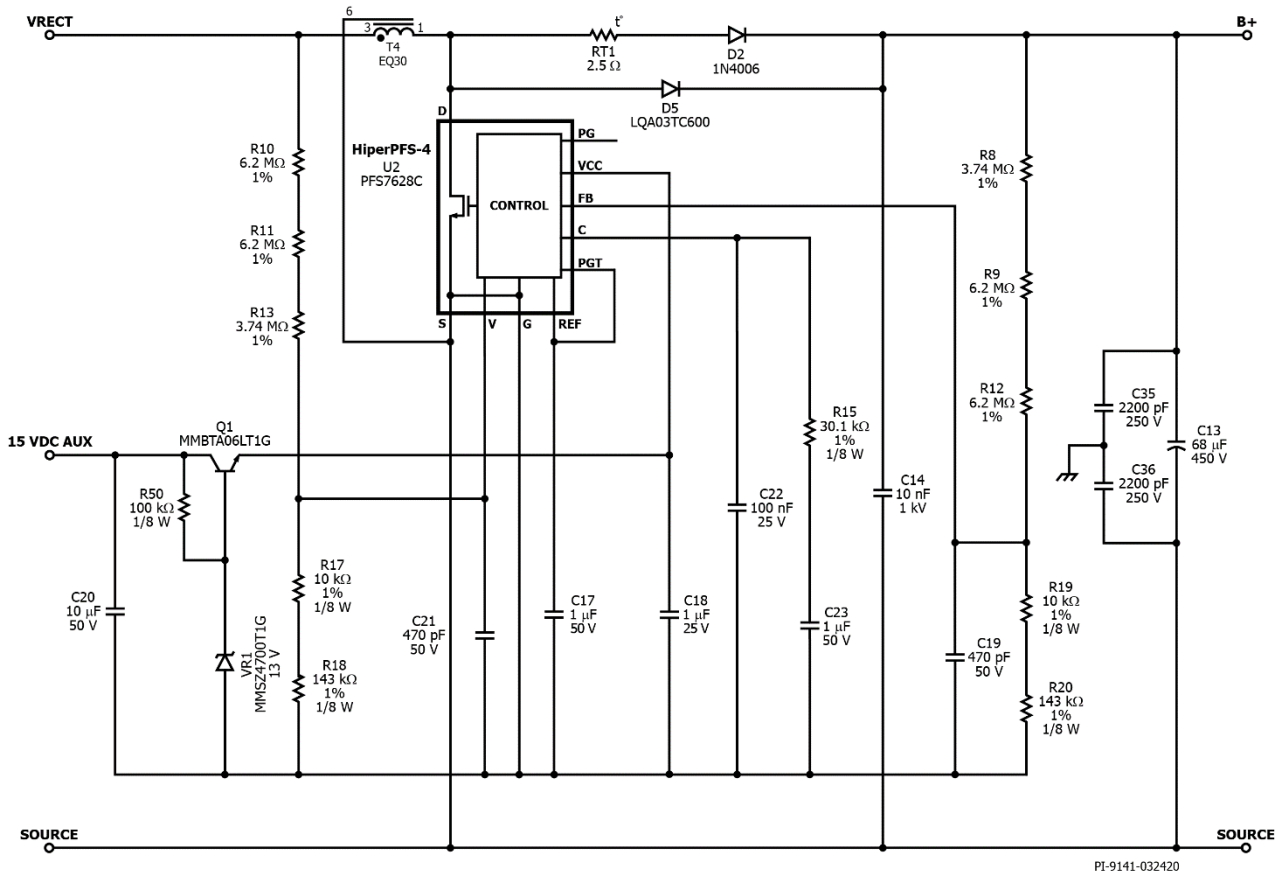

Figure 9 – Schematic, PFC Section.

The PFC converter stage mainly consists of the boost inductor T4, integrated power MOSFET and controller PFS7628C IC U2, and boost diode D5. The PFC boost converter maintains a sinusoidal input current while regulating a 410 VDC output voltage for the isolated flyback converter stage. Q-speed Q-series LQA03TC600 is used for the boost diode D5 to obtain a cost-effective solution that balances switching speed and EMI performance of the PFC boost topology.

At startup, NTC thermistor RT1 and diode D2 provides an initial path for the inrush current to the bulk capacitor C13. This path bypasses the boost inductor T4 and power switch U2 during startup in order to prevent a resonant interaction between the boost inductor T4 and bulk capacitor C13. The thermistor RT1 is placed here to minimize power loss across it.

A small ceramic capacitor C14 is placed near D5 to provide a short loop, high frequency return path to RTN. This effectively improves EMI performance and reduces U2 drain voltage overshoot during turn-off. Capacitor C17 on the REFERENCE (REF) pin serves as both a decoupling capacitor for the IC's internal reference, and also programs the output power for either full mode, 100% of rated power (C17 = 1 μF) or efficiency mode, 80%

of rated output power ($C17 = 0.1 \mu\text{F}$). This design utilizes the 'full' power mode for an optimized device performance.

4.2.1 Input Feed Forward Sense Circuit

PFS7628C U2 senses the input voltage through the VOLTAGE MONITOR (V) pin via the resistors R10, R11, R13, R17 and R18. Capacitor C21 acts as a bypass capacitor for the V pin of the IC.

4.2.2 PFC Output Feedback

PFS7628C U2 uses a scaled voltage proportional to the output PFC voltage as feedback to the IC's controller in order to set the output to 410 V. This is done via a resistive divider network R8, R9, R12, R19, and R20. Capacitor C19 decouples the U2 FEEDBACK (FB) pin. Resistor R15 and capacitor C23 is placed at the COMPENSATION (C) pin for loop compensation to provide control loop dominant pole. Capacitor C22 is added to attenuate high frequency noise. Its recommended values are 30.1 k Ω for R15, 1 μF for C23, and 100 nF for C22.

4.2.3 Bias Supply Series Regulator

PFS7628C U2 needs an external regulated VCC supply of 12 V nominal. This is provided through a bias voltage input of 27V DC from the auxiliary winding of the DC-DC stage. The bias voltage should be high enough to maintain high power factor at deep CV/CC operation, requiring that the PFC stage still operates. At 15 V during CV/CC, the supply from the bias is not enough to power the PFC stage. At this point, the PFC stage is bypassed via the inrush path provided by RT1 and D2 and the input voltage directly supplies the second-stage DC-DC flyback converter. In this condition, the power factor is around 0.5 due to the PFC being disabled.

A series regulator is formed by resistor R50, transistor Q1, and Zener diode VR1. This supplies a regulated 13 VDC to the VCC pin of U2. Capacitor C18 serves as a decoupling capacitor for the VCC pin. Capacitor C20 filters the voltage input from the bias supply.

4.3 **Second Stage: Isolated Flyback DC-DC Using LYTSwitch-6**

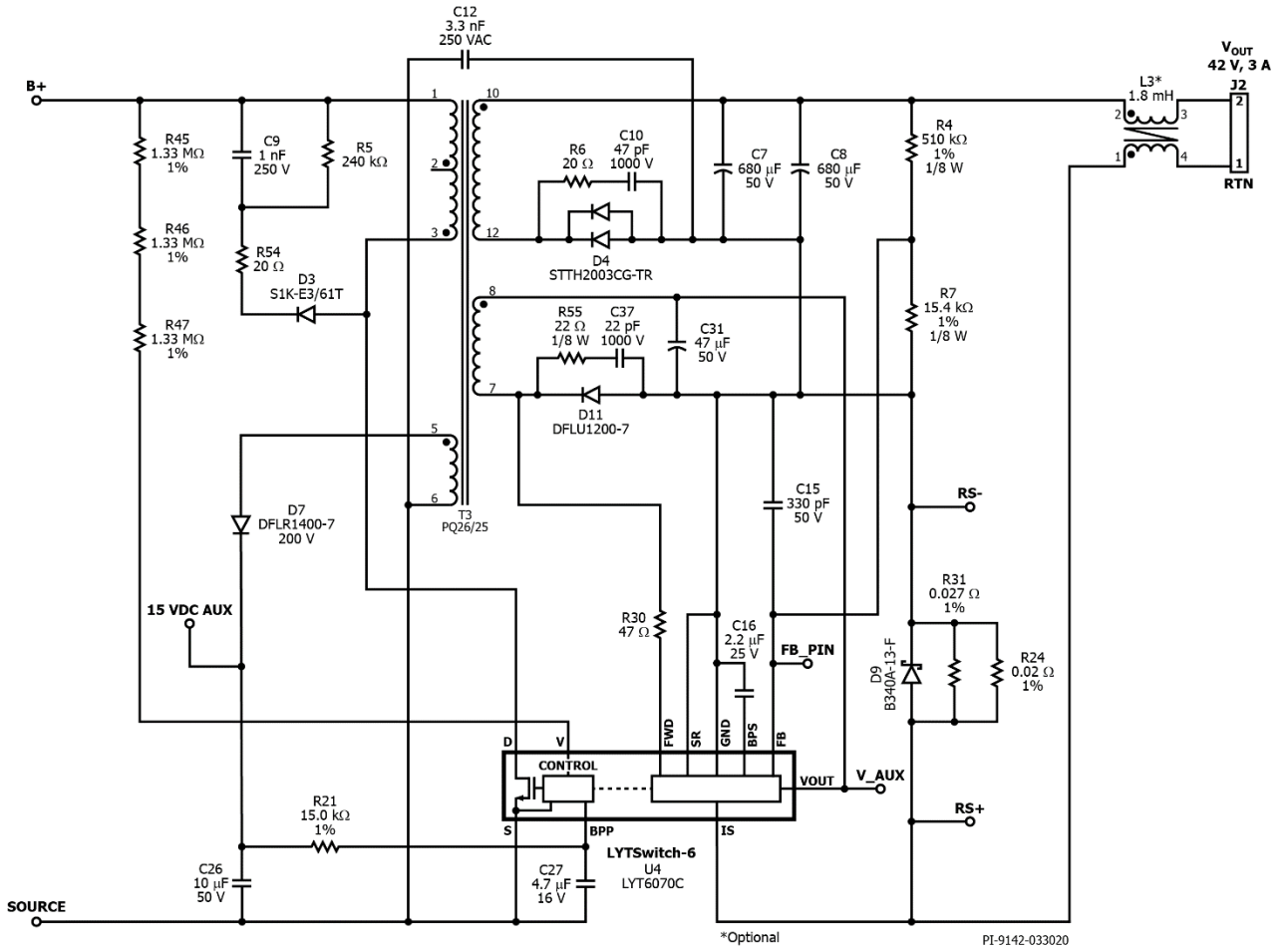

Figure 10 – Schematic, DCDC Flyback Section.



The second stage topology is an isolated flyback DC-DC power supply which uses LYTSwitch-6 IC U4. Transformer T3 is connected across the positive terminal of the bulk capacitor C13 and the 750 V power MOSFET integrated inside the LYTSwitch-6 IC. A low cost RCD clamp composed of D3, R54, C9, and R5 suppresses the peak drain voltage spike resulting from the transformer's leakage inductance.

The VOLTAGE MONITOR (V) pin of U4 is connected to the bulk capacitor C13 via resistors R45, R46, and R47 to provide input voltage information. A current threshold of I_{OV} is used to compute the resistance needed to trigger line overvoltage protection (line OVP). Once this is triggered, the LYTSwitch-6 IC U4 stops the power MOSFET from switching.

At startup, the PFC is still disabled and input voltage to the second stage is applied from the inrush path of RT1 and D2. To power the LYTSwitch-6 IC, an internal high voltage current source charges the BPP pin capacitor C27. Once the BPP capacitor is charged internally from the IC, the primary side assumes control and requires a handshake to turn over control to the secondary side. During normal operation, the primary side is powered by the primary auxiliary winding of the transformer T3. This auxiliary winding is configured as a flyback, rectified and filtered by D7 and C26 respectively and fed to the BPP pin through a current limiting resistor R21. Capacitor C27 serves as a decoupling capacitor and also as selection for the current limit setting of the IC U4. The two options are STANDARD (0.47 μ F) and INCREASED (4.7 μ F).

The secondary-side controller provides output voltage and output current sensing. The secondary winding voltage is rectified by the dual ultrafast recovery diodes in D4 and then filtered by output capacitors C7 and C8 to provide an approximately DC output. An RC snubber network R6 and C10 suppresses the voltage spike across D4 during turn off.

The secondary-side of the IC is powered from the secondary bias winding of transformer T3 through the OUTPUT VOLTAGE (VOUT) pin. Diode D11 rectifies the bias winding's voltage and capacitor C31 then filters it. The FORWARD (FWD) pin is connected to the switching node of the secondary auxiliary winding to provide information on the primary switching timing. During startup or short-circuit conditions, where the output voltage is low, the SECONDARY BYPASS (BPS) pin is powered through the FWD pin via resistor R30.

Output voltage is regulated by sensing thru resistor divider R4 and R7 with an internal reference of 1.265 V on the FEEDBACK (FB) pin. A filter capacitor C15 is added to filter unwanted noise that might trigger a false OVP or increase the output ripple.

Output current is regulated using external sense resistors R24 and R31 across ISENSE (IS) and GROUND (GND) pins. An internal threshold of 35.9 mV is continually compared in the IS pin. When this is exceeded, the device regulates the output current by changing



the switching frequency. Schottky diode d9 is added to protect the IS pin from overvoltage stress during output short-circuit conditions.

The secondary bias supply also provides power for the 3-way dimming circuit. The rectified bias winding supplies the series regulator, VR3, R53, Q6 and C32, with a regulated 13 V output to the dimming circuit.



4.4 **3-Way Dimming Control Circuit**

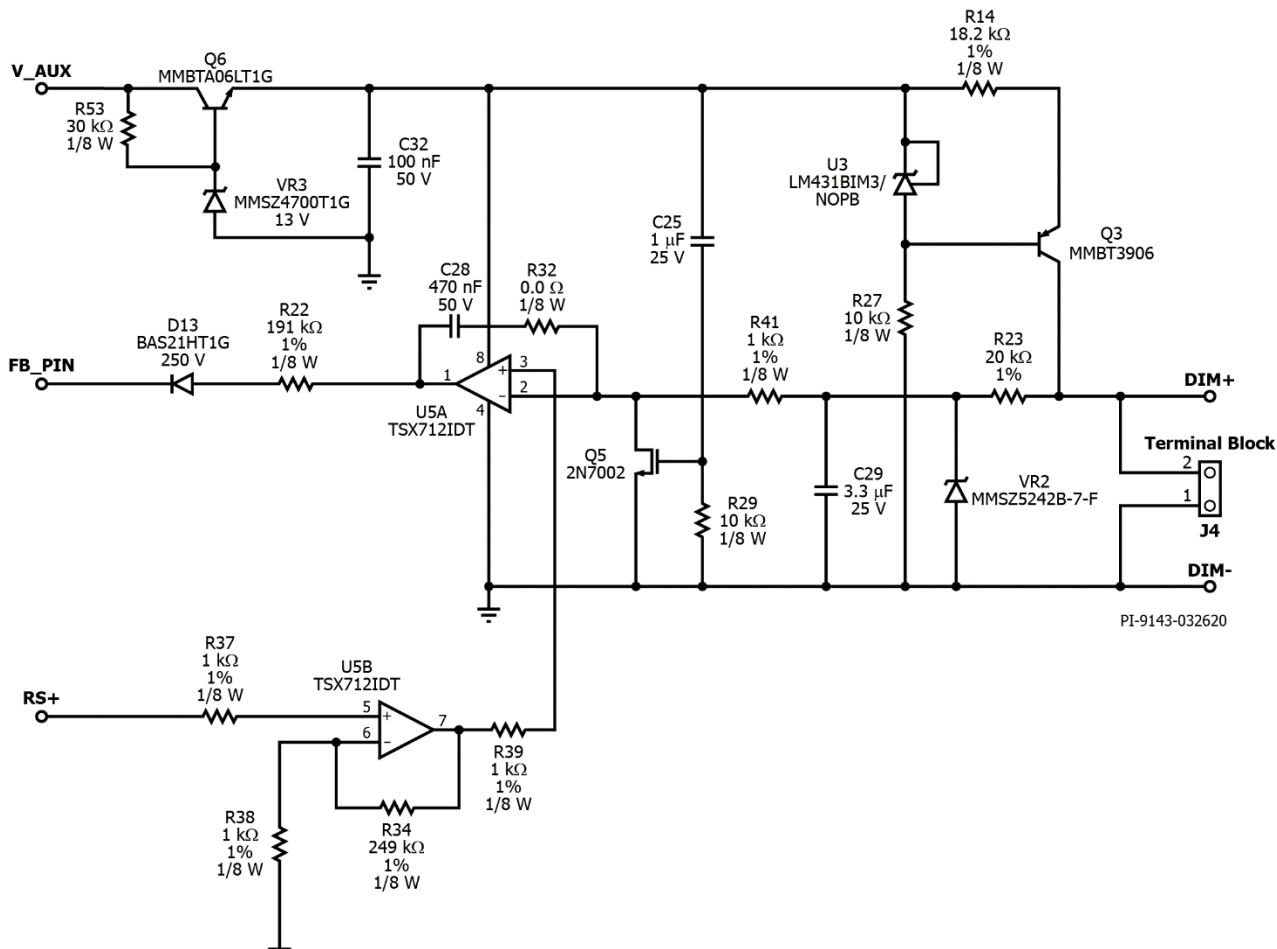

Figure 11 – 3-Way Dimming Schematic.

The 3-way dimming control circuit is shown in Figure 10. DIM+ and DIM- are the input terminals for three ways of dimming: 0 – 10 V dimming, variable duty PWM dimming, and variable resistance dimming. RS+ is connected to the IS pin which is used by the LYTSwitch-6 device to sense the output current. The voltage on the IS pin is the input to the non-inverting amplifier U5B. The gain is set at around 250 via resistors R34, R37, and R38. This results to approximately 10 V when the current is at maximum. The output of U5B is fed to the non-inverting input of U5A via resistor R39. The inverting input of U5A is the dimming input. Capacitor C28 and resistor R32 is added for compensation. The output of U5A injects current to the FB pin through D13 and limiting resistor R22. This happens whenever the output of U5B (from the IS pin) is higher than the dimming input. This current injection forces the output voltage to decrease but since the output is an LED string, the output voltage is held constant by the LED and the device forces the output current to compensate leading to output current reduction. The current injection loop may trigger feedback overvoltage with stepping the load from 100% to 0% during dimming. In order to avoid this, R22 is increased to slow down the current injection.

At startup, the initial output of U5 is low which results to unwanted spike in output current seen in LED string. To remove this spike, a blanking circuit Q5, R29, and C25 is added to the dimming circuit which initially pulls down the inverting input so that U5 output is set at high.

4.4.1 0 VDC – 10 VDC Dimming

During 0 – 10 V dimming, a DC voltage is applied across DIM+ and DIM-. Capacitor C29 will be charged to whatever DC voltage was applied via R23. This is also the voltage at the inverting terminal of U5A. Increasing this voltage will proportionally increase the output current. At 10 V, the output current is at maximum (3000 mA) and at 0 V, the output current is minimum (~ 0 mA). Zener diode VR2 protects the dimming circuitry from input dimming voltages in excess of 10 V.

4.4.2 Variable Duty PWM Input (10 V Peak)

During PWM dimming, a PWM signal with 10 V peak voltage is applied across DIM+ and DIM-. This PWM signal is averaged by the RC filter R23 and C29 resulting in a DC voltage fed to the inverting input of U5A. The voltage is proportional to the duty cycle of the PWM.

$$V_{- \text{ of } U5A} = D * V_{PEAK}$$

Where:

V- of U5A – voltage at the inverting pin of U5A

D – PWM duty cycle

V_{PEAK} – max. voltage of the PWM signal

The maximum voltage of the PWM input is at 10 V_{PK} and the minimum frequency set at 300 Hz. Resistor R23 and C29 are selected so that the time constant (RC) is much greater than the period of the minimum PWM frequency for better filtering.

4.4.3 Variable Resistance (0 Ω – 100 kΩ)

During variable resistance dimming, resistance is applied across DIM+ and DIM-. A constant current source circuit R14, U3, Q3, and R27 generates current to convert the variable resistance (0 Ω – 100 kΩ) into variable DC signal (0 V – 10 V). U3 clamps the voltage at R14, to set the emitter current at a constant value. The emitter current of Q3 is almost equal to its collector current, ~100 μA. This current flows to the variable resistance input thus generating the 0 V – 10 V needed at the inverting input of U5A.

5 PCB Layout

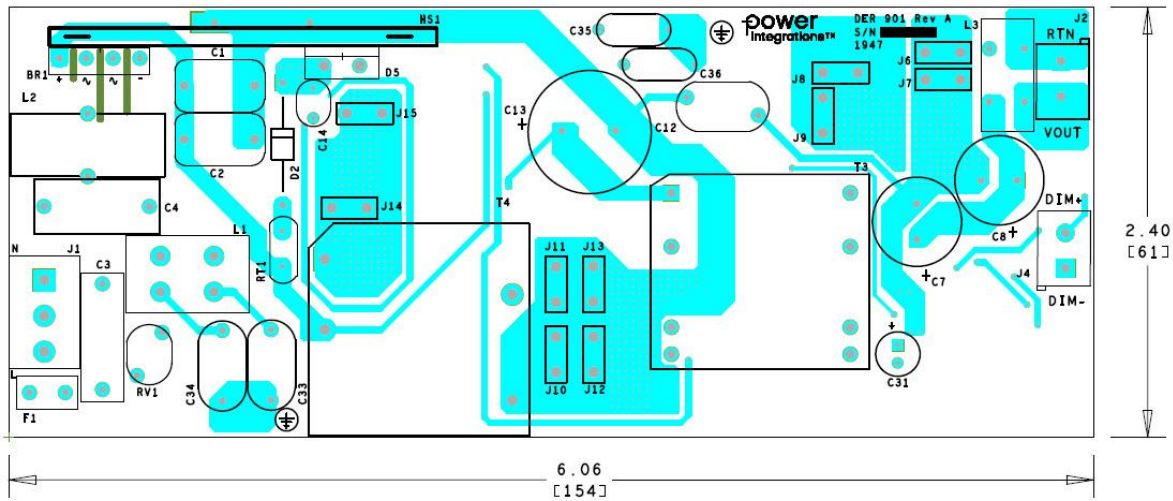

Figure 12 – Top Side.

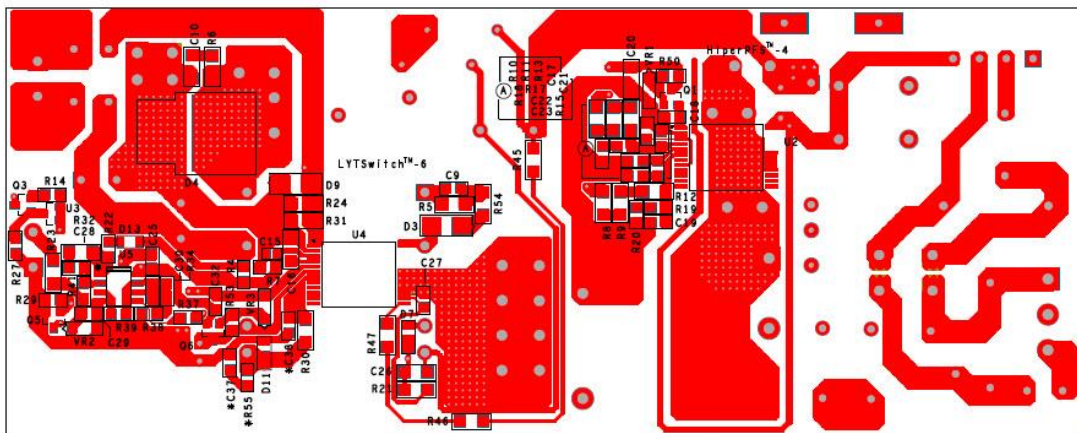

Figure 13 – Bottom Side.

6 Bill of Materials

6.1 Main BOM

Item	Qty	Ref Des	Description	Mfg Part Number	Mfg
1	1	BR1	Bridge Rectifier, 1000 V, 4 A, 4-ESIP, D3K, -55°C ~ 150°C (TJ), Vf=1V @ 7.5A	UD4KB100-BP	Micro Commercial
2	1	C1	330 nF, 450 V, METALPOLYPRO	ECW-F2W334JAQ	Panasonic
3	1	C2	330 nF, 450 V, METALPOLYPRO	ECW-F2W334JAQ	Panasonic
4	1	C3	150 nF, 310 VAC, X2	BFC233820154	Vishay
5	1	C4	330 nF, 310 VAC, Film, X2	B32922C3334M	Epcos
6	1	C7	680 µF, 50 V, Electrolytic, Gen. Purpose, (12.5 x 25)	UPW1H681MHD	Nichicon
7	1	C8	680 µF, 50 V, Electrolytic, Gen. Purpose, (12.5 x 25)	UPW1H681MHD	Nichicon
8	1	C9	1 nF, 250 V, Ceramic, X7R, 0805	GRM21AR72E102KW01D	Murata
9	1	C10	47 pF, 1000 V, Ceramic, NPO, 1206	C1206C470JDGACTU	Kemet
10	1	C12	3.3 nF, Ceramic, Y1	440LD33-R	Vishay
11	1	C13	68 µF, 20%, 450 V, Electrolytic, 10000 Hrs @ 105°C, (18 x 25)	450BXW68MEFC18X25	Rubycon
12	2	C14	10 nF, 1 kV, Disc Ceramic, X7R	SV01AC103KAR	AVX
13	1	C15	330 pF 50 V, Ceramic, X7R, 0603	CC0603KRX7R9BB331	Yageo
14	1	C16	2.2 µF, 25 V, Ceramic, X7R, 1206	TMK316B7225KL-T	Taiyo Yuden
15	1	C17	1 µF, ±10%, 50 V, Ceramic, X7R, Boardflex Sensitive, 0805, -55°C ~ 125°C	CGA4J3X7R1H105K125AE	TDK
16	1	C18	1 uF, ±10%, 25 V, Ceramic, X7R, 0805	GCM21BR71E105KA56L	Murata
17	1	C19	470 pF, 50 V, Ceramic, X7R, 0805	CC0805KRX7R9BB471	Yageo
18	1	C20	10 µF, 10%, 50V, Ceramic, X7R, -55°C ~ 125°C, 1206, 0.126" L x 0.063" W (3.20mm x 1.60mm)	CL31B106KBHNNNE	Samsung
19	1	C21	470 pF, 50 V, Ceramic, X7R, 0805	CC0805KRX7R9BB471	Yageo
20	1	C22	100 nF, 25 V, Ceramic, X7R, 0805	08053C104KAT2A	AVX
21	1	C23	1 µF, ±10%, 50 V, Ceramic, X7R, Boardflex Sensitive, 0805, -55°C ~ 125°C	CGA4J3X7R1H105K125AE	TDK
22	1	C25	1 µF, ±20%, 50 V, Ceramic, X7R, Boardflex Sensitive, 0805	CGA4J3X7R1H105M125AE	TDK
23	1	C26	10 µF, 10%, 50V, Ceramic, X7R, -55°C ~ 125°C, 1206 (3216 Metric), 0.126" L x 0.063" W (3.20mm x 1.60mm)	CL31B106KBHNNNE	Samsung
24	1	C27	4.7 µF, 16 V, Ceramic, X7R, 0805	CL21B475KOFNNNE	Samsung
25	1	C28	470 nF, 100 V, Ceramic, X7R, 1206	C3216X7R2A474K	TDK
26	1	C29	3.3 µF, 25 V, Ceramic, X7R, 0805	C2012X7R1E335K	TDK
27	1	C31	47 µF, 50 V, Electrolytic, Gen. Purpose, (6.3 x 11)	EKMG500ELL470MF11D	Nippon Chemi-Con
28	1	C32	100 nF, 50 V, Ceramic, X7R, 0805	CC0805KRX7R9BB104	Yageo
29	1	C33	2200 pF, ±20%, 250 VAC, X1, Y1, Disc Ceramic	DE1E3KX222MN4AN01F	Murata
30	1	C34	2200 pF, ±20%, 250 VAC, X1, Y1, Disc Ceramic	DE1E3KX222MN4AN01F	Murata
31	1	C35	2200 pF, ±20%, 250 VAC, X1, Y1, Disc Ceramic	DE1E3KX222MN4AN01F	Murata
32	1	C36	2200 pF, ±20%, 250 VAC, X1, Y1, Disc Ceramic	DE1E3KX222MN4AN01F	Murata
33	1	C37	22 pF, 1000 V, Ceramic, NPO, 0805	C0805C220JDGACTU	Kemet
34	1	C38	100 pF, 200 V, Ceramic, COG, 0805	08052A101JAT2A	AVX
35	1	D2	800 V, 1 A, GP, Rectifier, DO-41	1N4006-E3/54	Vishay
36	1	D3	800 V, 1 A, DO214AC	S1K-E3/61T	Vishay
37	1	D4	Diode Array, 1 Pair, Common Cathode, Standard, 300 V, 1 0A, SMT TO-263-3, D ² Pak (2 Leads + Tab), TO-263AB	STTH2003CG-TR	ST Micro
38	1	D5	600 V, 3 A, TO-220AC	LQA03TC600	Power Integrations
39	1	D7	400 V, 1 A, Rectifier, Glass Passivated, POWERDI123	DFLR1400-7	Diodes, Inc.
40	1	D9	Diode, SCHOTTKY, 40 V, 3 A, SMA, DO-214AA	B340A-13-F	Diodes, Inc.
41	1	D11	Diode, UFAST, 200 V, 1 A, POWERDI123	DFLU1200-7	Diodes, Inc.
42	1	D13	Diode, General Purpose, Power, Switching, SS SWCH DIO, 250V, SC-76, SOD-323	BAS21HT1G	ON Semi
43	1	F1	3.15 A, 250 V, Slow, RST	507-1181	Belfuse
44	1	L1	20 mH, Common Mode Choke custom DER 801, AEC-Q200	30-04099-00	Power Integrations

45	1	L2	470 μ H, 1.6A, Vertical Toroidal	2120-V-RC	Bourns
46	1	Q1	NPN, Small Signal BJT, 80 V, 0.5 A, SOT-23	MMBTA06LT1G	ON Semi
47	1	Q3	PNP, Small Signal BJT, 40 V, 0.2 A, SOT-23	MMBT3906LT1G	ON Semi
48	1	Q5	60 V, 115 mA, SOT23-3	2N7002-7-F	Diodes, Inc.
49	1	Q6	NPN, Small Signal BJT, 80 V, 0.5 A, SOT-23	MMBTA06LT1G	ON Semi
50	1	R4	RES, 510 k Ω , 1%, 1/8 W, Thick Film, 0805	ERJ-6ENF5103V	Panasonic
51	1	R5	RES, 240 k Ω , 5%, 1/4 W, Thick Film, 1206	ERJ-8GEYJ244V	Panasonic
52	1	R6	RES, 20 Ω , 5%, 1/4 W, Thick Film, 1206	ERJ-8GEYJ200V	Panasonic
53	1	R7	RES, 15.4 k Ω , 1%, 1/8 W, Thick Film, 0805	ERJ-6ENF1542V	Panasonic
54	1	R8	RES, 3.74 M Ω , 1%, 1/4 W, Thick Film, 1206	CRCW12063M74FKEA	Vishay
55	1	R9	RES, 6.2 M Ω , 1%, 1/4 W, Thick Film, 1206	KTR18EZPF6204	Rohm
56	1	R10	RES, 6.2 M Ω , 1%, 1/4 W, Thick Film, 1206	KTR18EZPF6204	Rohm
57	1	R11	RES, 6.2 M Ω , 1%, 1/4 W, Thick Film, 1206	KTR18EZPF6204	Rohm
58	1	R12	RES, 6.2 M Ω , 1%, 1/4 W, Thick Film, 1206	KTR18EZPF6204	Rohm
59	1	R13	RES, 3.74 M Ω , 1%, 1/4 W, Thick Film, 1206	CRCW12063M74FKEA	Vishay
60	1	R14	RES, 18.2 k Ω , 1%, 1/8 W, Thick Film, 0805	ERJ-6ENF1822V	Panasonic
61	1	R15	RES, 30.1 k Ω , 1%, 1/8 W, Thick Film, 0805	ERJ-6ENF3012V	Panasonic
62	1	R17	RES, 10.0 k Ω , 1%, 1/8 W, Thick Film, 0805	ERJ-6ENF1002V	Panasonic
63	1	R18	RES, 143 k Ω , 1%, 1/8 W, Thick Film, 0805	ERJ-6ENF1433V	Panasonic
64	1	R19	RES, 10.0 k Ω , 1%, 1/8 W, Thick Film, 0805	ERJ-6ENF1002V	Panasonic
65	1	R20	RES, 143 k Ω , 1%, 1/8 W, Thick Film, 0805	ERJ-6ENF1433V	Panasonic
66	1	R21	RES, 15.0 k Ω , 1%, 1/4 W, Thick Film, 1206	ERJ-8ENF1502V	Panasonic
67	1	R22	RES, 191 k Ω , 1%, 1/8 W, Thick Film, 0805	ERJ-6ENF1913V	Panasonic
68	1	R23	RES, 20.0 k Ω , 1%, 1/4 W, Thick Film, 1206	ERJ-8ENF2002V	Panasonic
69	1	R24	RES, 0.02 Ω , 1%, 1/4 W, Thick Film, 0805	RL0805FR-7W0R02L	Yageo
70	1	R27	RES, 10 k Ω , 5%, 1/8 W, Thick Film, 0805	ERJ-6GEYJ103V	Panasonic
71	1	R29	RES, 10 k Ω , 5%, 1/8 W, Thick Film, 0805	ERJ-6GEYJ103V	Panasonic
72	1	R30	RES, 47 Ω , 5%, 1/4 W, Thick Film, 1206	ERJ-8GEYJ470V	Panasonic
73	1	R31	RES, 27 m Ω , \pm 1%, 1/4 W, Chip Resistor, 1206, Current Sense, Moisture Resistant, Thick Film	RL1206FR-070R027L	Yageo
74	1	R32	RES, 0 Ω , 5%, 1/8 W, Thick Film, 0805	ERJ-6GEY0R00V	Panasonic
75	1	R34	RES, 249 k Ω , 1%, 1/8 W, Thick Film, 0805	ERJ-6ENF2493V	Panasonic
76	1	R37	RES, 1.00 k Ω , 1%, 1/8 W, Thick Film, 0805	ERJ-6ENF1001V	Panasonic
77	1	R38	RES, 1.00 k Ω , 1%, 1/8 W, Thick Film, 0805	ERJ-6ENF1001V	Panasonic
78	1	R39	RES, 1.00 k Ω , 1%, 1/8 W, Thick Film, 0805	ERJ-6ENF1001V	Panasonic
79	1	R41	RES, 1.00 k Ω , 1%, 1/8 W, Thick Film, 0805	ERJ-6ENF1001V	Panasonic
80	1	R45	RES, 1.33 M Ω , 1%, 1/4 W, Thick Film, 1206	RC1206FR-071M33L	Yageo
81	1	R46	RES, 1.33 M Ω , 1%, 1/4 W, Thick Film, 1206	RC1206FR-071M33L	Yageo
82	1	R47	RES, 1.33 M Ω , 1%, 1/4 W, Thick Film, 1206	RC1206FR-071M33L	Yageo
83	1	R50	RES, 100 k Ω , 5%, 1/8 W, Thick Film, 0805	ERJ-6GEYJ104V	Panasonic
84	1	R53	RES, 30 k Ω , 5%, 1/8 W, Thick Film, 0805	ERJ-6GEYJ303V	Panasonic
85	1	R54	RES, 20 Ω , 5%, 1/4 W, Thick Film, 1206	ERJ-8GEYJ200V	Panasonic
86	1	R55	RES, 22 Ω , 5%, 1/8 W, Thick Film, 0805	ERJ-6GEYJ220V	Panasonic
87	1	RT1	NTC Thermistor, 2.5 Ω , 3 A	SL08 2R503	Ametherm
88	1	RV1	300 VAC, 25 J, 7 mm, RADIAL	V300LA4P	Littlefuse
89	1	T3	Bobbin, PQ26/25, Vertical, 12 pins	PQ26X25	Pin Shine
90	1	T4	Bobbin, EQ30, 10 pins, Vertical (low profile)	CSV-EQ30-1S-10P	Ferroxcube
91	1	U2	HiperPFS-4, InSOP24B	PFS7628C	Power Integrations
92	1	U3	IC, REG ZENER SHUNT ADJ SOT-23	LM431BIM3/NOPB	National Semi
93	1	U4	LYT6070C, LYTSwitch-6 Integrated Circuit, InSOP24D	LYT6070C	Power Integrations
94	1	U5	IC, DUAL Op Amp, General Purpose, 2.7MHz, Rail to Rail,8-SOIC (0.154", 3.90 mm Width),8-SO	TSX712IDT	ST Micro
95	1	VR1	13 V, 5%, 500 Mw, SOD-123	MMSZ4700T1G	ON Semi
96	1	VR2	DIODE ZENER 12 V 500 mW SOD123	MMSZ5242B-7-F	Diodes, Inc.
97	1	VR3	13 V, 5%, 500 Mw, SOD-123	MMSZ4700T1G	Diodes, Inc.
98	1	BR1	Bridge Rectifier, 1000 V, 4 A, 4-ESIP, D3K, -55°C ~ 150°C (TJ), Vf=1V @ 7.5A	UD4KB100-BP	Micro Commercial



OPTIONAL COMPONENTS					
99	1	L3	Toroidal Common Mode Choke, 1.8 mH, CUSTOM, DER 801	32-00375-00	Power Integrations

6.2 *Miscellaneous Parts*

Item	Qty	Ref	Description	Mfg Part Number	Mfg
1	1	HS1	SHTM, HEATSINK, DERDER801 PRIMARY		Custom
2	1	HS2	FAB, HEATSINK,Hiper-PFS, DER394		Custom
3	1	J1	CONN TERM BLOCK 5.08 mm 3POS, Screw - Leaf Spring, Wire Guard	ED120/3DS	On Shore Technology
4	1	J2	CONN TERM BLOCK, 2 POS, 5mm, PCB	ED500/2DS	On Shore Technology
5	1	J4	CONN TERM BLOCK, 2 POS, 5mm, PCB	ED500/2DS	On Shore Technology
6	1	J6	CONN QC TAB 0.250 SOLDER	1287-ST	KeyStone Electronics
7	1	J7	CONN QC TAB 0.250 SOLDER	1287-ST	KeyStone Electronics
8	1	J8	CONN QC TAB 0.250 SOLDER	1287-ST	KeyStone Electronics
9	1	J9	CONN QC TAB 0.250 SOLDER	1287-ST	KeyStone Electronics
10	1	J10	CONN QC TAB 0.250 SOLDER	1287-ST	KeyStone Electronics
11	1	J11	CONN QC TAB 0.250 SOLDER	1287-ST	KeyStone Electronics
12	1	J12	CONN QC TAB 0.250 SOLDER	1287-ST	KeyStone Electronics
13	1	J13	CONN QC TAB 0.250 SOLDER	1287-ST	KeyStone Electronics
14	1	J14	CONN QC TAB 0.250 SOLDER	1287-ST	KeyStone Electronics
15	1	J15	CONN QC TAB 0.250 SOLDER	1287-ST	KeyStone Electronics
16	1	SCREW3	SCREW MACHINE PHIL 6-32 X 3/8 SS	PMSSS 632 0038 PH	Building Fasteners
17	1	SCREW4	SCREW MACHINE PHIL 6-32 X 3/8 SS	PMSSS 632 0038 PH	Building Fasteners



7 PFC Inductor Specification (T4)

7.1 Electrical Diagram

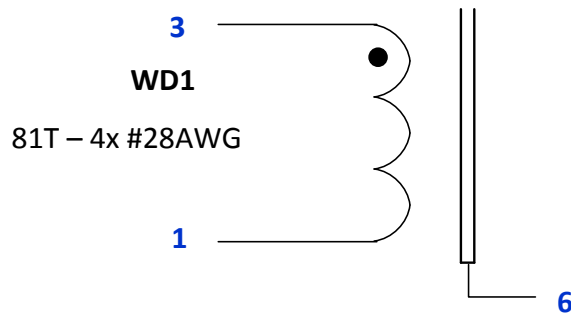

Figure 14 – PFC Inductor Electrical Diagram.

7.2 Electrical Specifications

Parameter	Condition	Spec.
Nominal Primary Inductance	Measured at 1 V _{PK-PK} , 100 kHz switching frequency, between pin 3 and pin 1.	998 μH
Tolerance	Tolerance of Primary Inductance.	±5%

7.3 Material List

Item	Description
[1]	Core: EQ30 PC95 or Equivalent.
[2]	Bobbin: EQ30, 10 Pins.
[3]	Magnet Wire: #28 AWG.
[4]	Transformer Tape: 3M 1298 Polyester Film, 8.5 mm Wide.
[5]	Transformer Tape: 3M 1298 Polyester Film, 19.5 mm Wide.
[6]	Copper Strip with Adhesive: 6 mm.

7.4 **PFC Inductor Build Diagram (T4)**

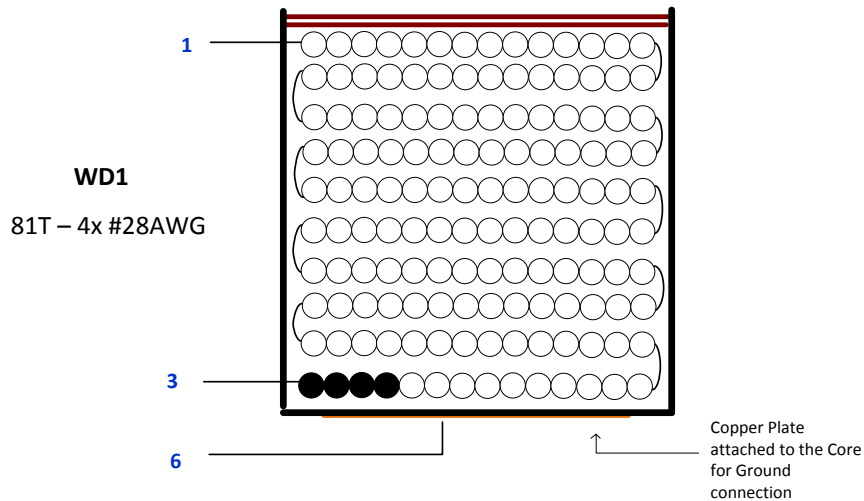
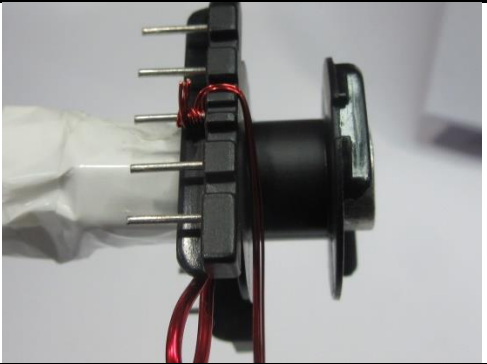
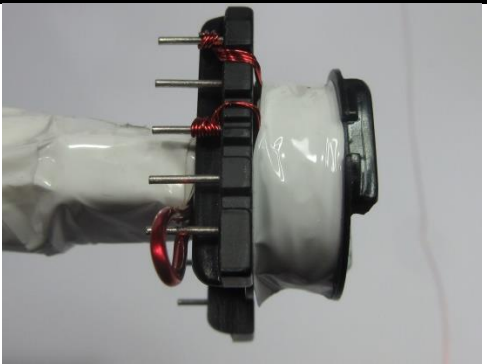
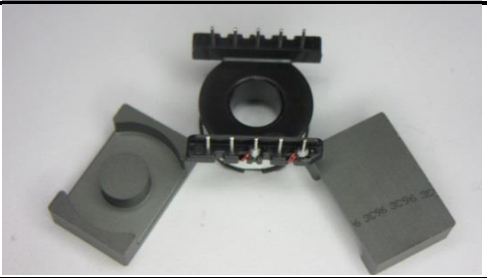
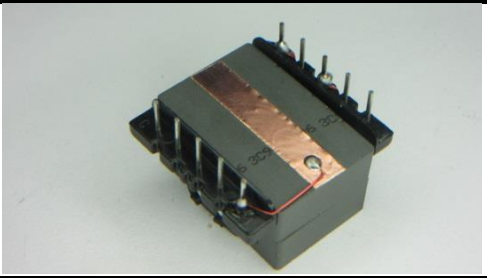



Figure 15 – PFC Inductor Build Diagram.

7.5 **PFC Inductor Construction (T4)**

Winding Directions	Bobbin, Item [2], is oriented on winder jig such that terminal pin 1-5 is on the left side. The winding direction is counterclockwise.
Winding	Use Item [3], start at pin 3 and wind quad-filar wire across the bobbin width.
Winding	Continue winding across the bobbin width up to 81 turns and terminate at pin 1.
Insulation	Add 2 layers of tape, Item [4], for insulation.
Core Grinding	Grind the center leg of one core, Item [1], until it meets the nominal inductance of 998 μ H.
Assemble Core	Assemble the 2 cores on the bobbin and place copper strip, Item [6] on the bottom core. Solder a wire from copper strip to pin 6.
Insulation	Wrap the core with Item [5].
Pins	Pull out terminals 2, 4, 5, 7, 8, 9, and 10.
Finish	Dip the transformer in varnish.

7.6 **Winding Illustrations**

<p>Winding Directions</p>	<p>Bobbin, Item [2], is oriented on winder jig such that terminal pin 1-5 is on the left side. The winding direction is counterclockwise. Use Item [3], start quad-filar wire at pin 3.</p>	
<p>Winding and Insulation</p>	<p>Wind across the bobbin width up to 117 turns. Terminate wire at pin 1. Add 2 layers of tape, Item [4], for insulation.</p>	
<p>Core Grinding</p>	<p>Grind the center leg of one core, Item [1], until it meets the nominal inductance of 998 μH.</p>	
<p>Assemble Core</p>	<p>Assemble the 2 cores on the bobbin and place copper strip, Item [6] on the bottom core. Solder a wire from copper strip to pin 6.</p>	
<p>Insulation</p>	<p>Wrap the core with Item [5].</p>	

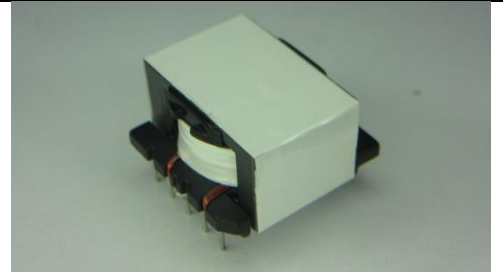
Pins	Pull out terminals 2, 4, 5, 7, 8, 9, and 10.	
Finish	Dip the transformer in varnish.	

8 Transformer Specification (T3)

8.1 Electrical Diagram

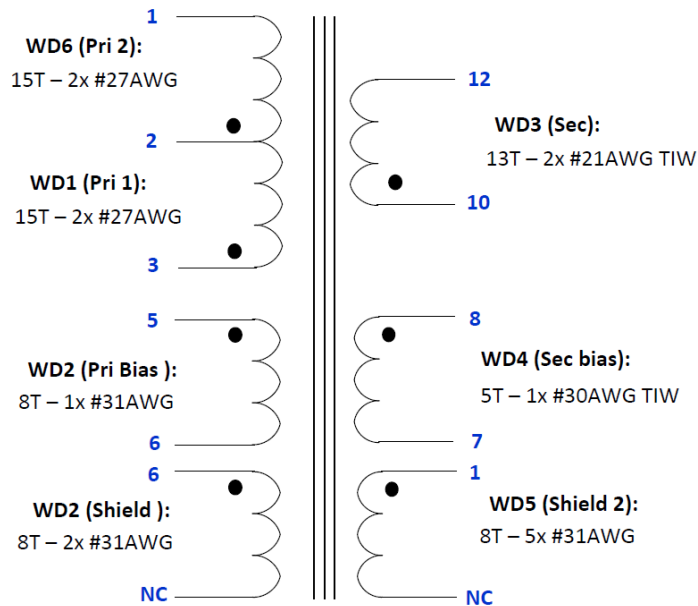

Figure 16 – Transformer Electrical Diagram.

8.2 Electrical Specifications

Parameter	Condition	Spec.
Nominal Primary Inductance	Measured at 1 V _{PK-PK} , 100 kHz switching frequency, between pin 3 and pin 1.	352 μH
Tolerance	Tolerance of Primary Inductance.	±5%
Leakage Inductance	Measured at 1 V _{PK-PK} , 100 kHz switching frequency, between pin 3 and pin 1 with all other windings shorted.	<5 μH

8.3 Material List

Item	Description
[1]	Core: PQ26/25 PC95 or Equivalent.
[2]	Bobbin: PQ26/25, 12 Pins.
[3]	Magnet Wire: #27 AWG.
[4]	Magnet Wire: #31 AWG.
[5]	Triple-Insulated Wire: #30 AWG.
[6]	Triple-Insulated Wire: #21 AWG.
[7]	Transformer Tape: 3M 1298 Polyester Film, 13.5 mm Wide.
[8]	Transformer Tape: 3M 1298 Polyester Film, 9.6 mm Wide.

8.4 **Transformer Build Diagram (T3)**

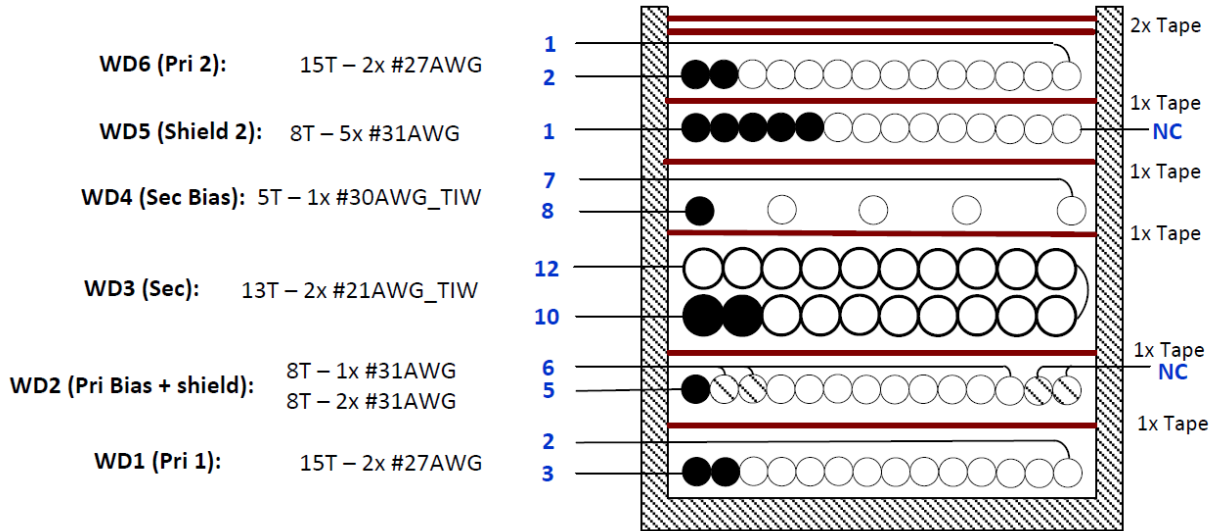
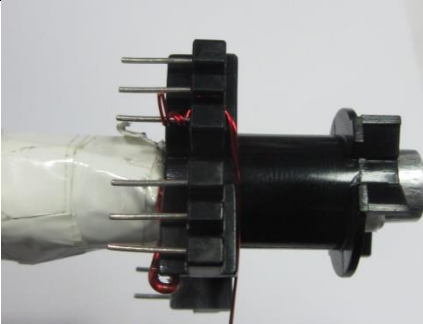
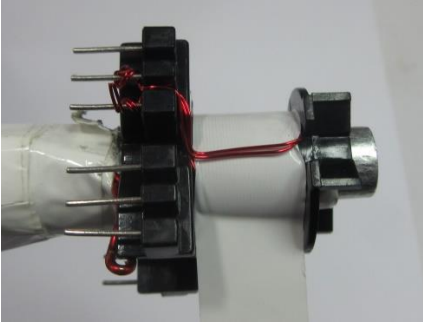
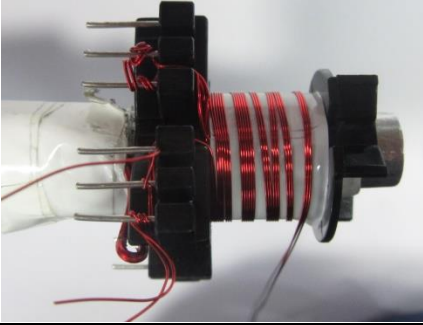
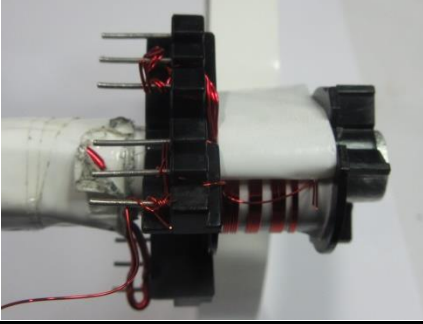
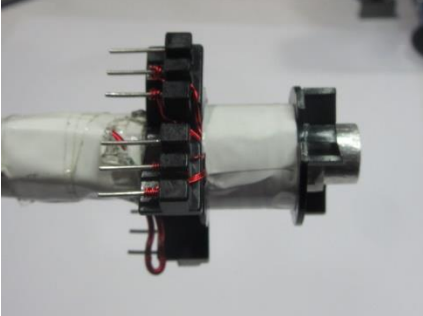

Figure 17 – Transformer Build Diagram.

8.5 **Transformer Construction (T3)**

Winding Directions	Bobbin, Item [2], is oriented on winder jig such that terminal pin 1-6 is on the left side. The winding direction is counterclockwise.
Winding 1	Use Item [3], bifilar, start at pin 3 and wind across the bobbin width up to 15 turns. Terminate wire to pin 2.
Insulation	Add 1 layer of tape, Item [7], for insulation.
Winding 2	Use Item [4] and start at pin 5. Use another piece of Item [4], bifilar, and start at pin 6. Wind both pieces at the same time up to 8 turns. Terminate the first piece of Item [4] at pin 6. The second piece of Item [4] shall be left unterminated.
Insulation	Add 1 layer of tape, Item [7], for insulation.
Winding 3	Use Item [6], bifilar, start at pin 10 and wind 2 layers across the bobbin width up to 13 turns. Terminate wire to pin 12.
Insulation	Add 1 layer of tape, Item [7], for insulation.
Winding 4	Use Item [5], start at pin 8 and wind across the bobbin width up to 5 turns. Terminate wire to pin 7.
Insulation	Add 1 layer of tape, Item [7], for insulation.
Winding 5	Use Item [4], 5-filar, start at pin 1 and wind across the bobbin width up to 8 turns. Leave the other end unterminated.
Insulation	Add 1 layer of tape, Item [7], for insulation.
Winding 6	Use Item [3], bifilar, start at pin 2 and wind across the bobbin width up to 15 turns. Terminate wire to pin 1.
Insulation	Add 2 layers of tape, Item [7], for insulation.
Core Grinding	Grind the center leg of one core, Item [1], until it meets the nominal inductance of 352 μ H.
Assemble Core	Assemble the 2 cores on the bobbin.
Insulation	Wrap the core with Item [8].
Pins	Pull out terminals 2, 4, 9 and 11.
Finish	Dip the transformer in varnish.

8.6 **Winding Illustrations**

<p>Winding Directions</p>	<p>Bobbin, Item [2], is oriented on winder jig such that terminal pin 1-6 is on the left side. The winding direction is counterclockwise. Using Item [3], start at pin 3.</p>	
<p>Winding 1 and Insulation</p>	<p>Wind across the bobbin width up to 28 turns. Terminate wire to pin 2. Add 1 layer of tape, Item [7], for insulation.</p>	
<p>Winding 2</p>	<p>Use Item [4] and start at pin 5. Use another piece of Item [4], bifilar, and start at pin 6. Wind both pieces at the same time up to 8 turns.</p>	
<p>Winding 2</p>	<p>Terminate the first piece of Item [4] at pin 6. The second piece of Item [4] shall be left unterminated.</p>	
<p>Insulation</p>	<p>Add 1 layer of tape, Item [7], for insulation.</p>	

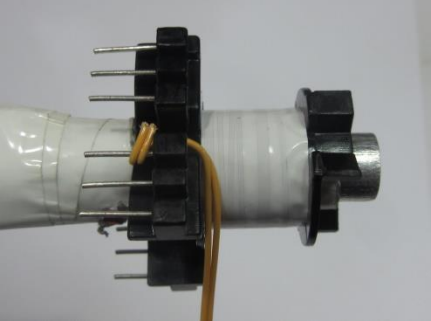
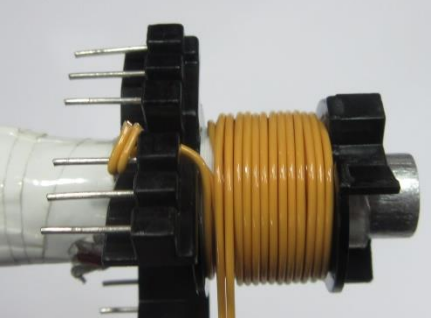
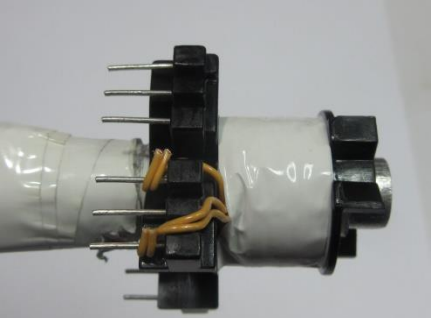
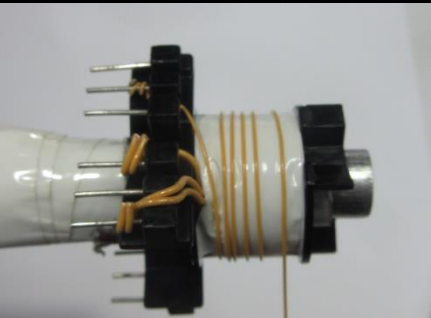
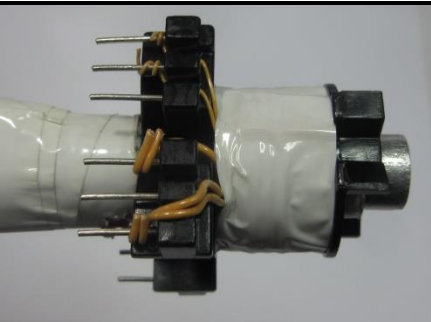
<p>Winding 3</p>	<p>Use Item [6], bifilar, start at pin 10.</p>	
<p>Winding 3</p>	<p>Wind 2 layers across the bobbin width up to 13 turns. Terminate wire to pin 12.</p>	
<p>Insulation</p>	<p>Add 1 layer of tape, Item [7], for insulation.</p>	
<p>Winding 4</p>	<p>Use Item [5], start at pin 8 and wind across the bobbin width up to 5 turns. Terminate wire to pin 7.</p>	
<p>Insulation</p>	<p>Add 1 layer of tape, Item [7], for insulation.</p>	

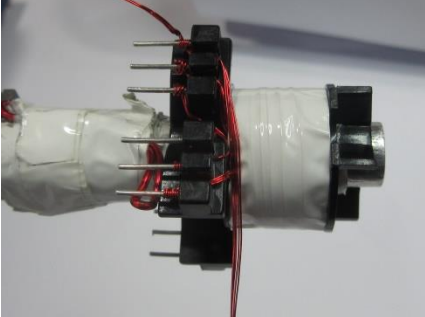
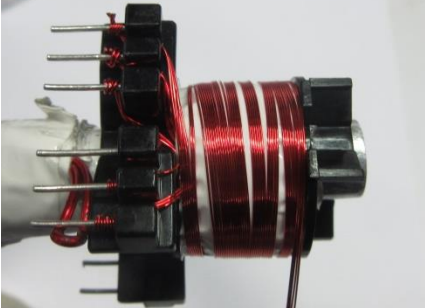
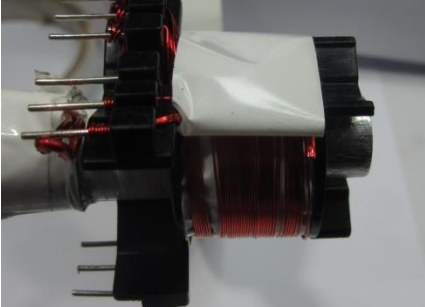
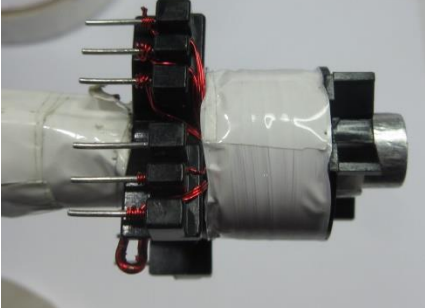
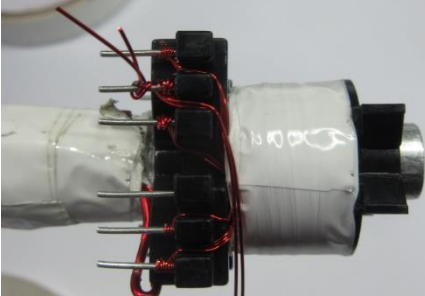
<p>Winding 5</p>	<p>Use Item [4], 5-filar, start at pin 1.</p>	
<p>Winding 5</p>	<p>Wind across the bobbin width up to 8 turns.</p>	
<p>Winding 5</p>	<p>Leave the other end unterminated.</p>	
<p>Insulation</p>	<p>Add 1 layer of tape, Item [7], for insulation.</p>	
<p>Winding 6</p>	<p>Use Item [3], bifilar, start at pin 2.</p>	

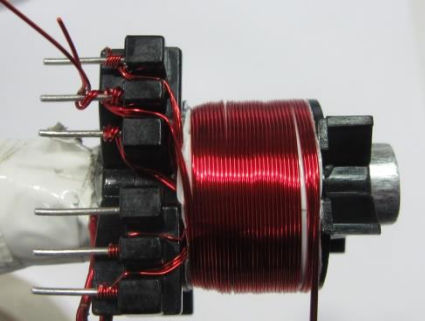
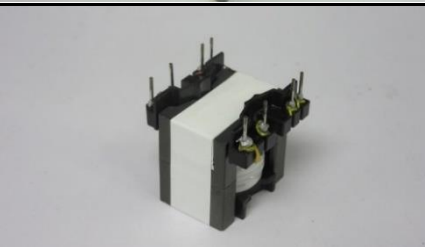
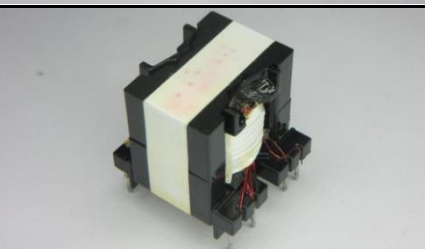
<p>Winding 6</p>	<p>Wind across the bobbin width up to 15 turns. Terminate wire to pin 1.</p>	
<p>Insulation</p>	<p>Add 2 layers of tape, Item [7], for insulation.</p>	
<p>Core Grinding</p>	<p>Grind the center leg of one core, Item [1], until it meets the nominal inductance of 352 μH.</p>	
<p>Assemble Core</p>	<p>Assemble the 2 cores on the bobbin. Wrap the core with Item [8].</p>	
<p>Pins</p>	<p>Pull out terminals 2, 4, 9 and 11.</p>	
<p>Finish</p>	<p>Dip the transformer in varnish.</p>	

9 Design Spreadsheet

9.1 HiperPFS-4 Design Spreadsheet

Hiper_PFS-4_Boost_062918; Rev.1.1; Copyright Power Integrations 2018	INPUT	INFO	OUTPUT	UNITS	Continuous Mode Boost Converter Design Spreadsheet
Enter Application Variables					
Input Voltage Range	Universal		Universal		Input voltage range
VACMIN	100		100	VAC	Minimum AC input voltage. Spreadsheet simulation is performed at this voltage. To examine operation at other voltages, enter here, but enter fixed value for LPFC_ACTUAL.
VACMAX	277		277	VAC	Maximum AC input voltage
VBROWNIN		Info	84	VAC	Brown-IN voltage has been modified since the V-pin ratio is no longer 100:1
VBROWNOUT		Info	73	VAC	Brown-OUT voltage has been modified since the V-pin ratio is no longer 100:1
VO	410	Info	410	VDC	Brown IN/OUT voltage has changed due to modifications in the V-pin ratio from 100:1. Recommend Vpin ratio= FB pin ratio for optimized operation. Check the PF, input current distortion, brown in/out and power delivery
PO	135		135	W	Nominal Output power
fL			50	Hz	Line frequency
TA Max			40	°C	Maximum ambient temperature
n			0.93		Enter the efficiency estimate for the boost converter at VACMIN. Should approximately match calculated efficiency in Loss Budget section
VO_MIN			390	VDC	Minimum Output voltage
VO_RIPPLE_MAX			20	VDC	Maximum Output voltage ripple
tHOLDUP	15		15	ms	Holdup time
VHOLDUP_MIN			328	VDC	Minimum Voltage Output can drop to during holdup
I_INRUSH			40	A	Maximum allowable inrush current
Forced Air Cooling	No		No		Enter "Yes" for Forced air cooling. Otherwise enter "No". Forced air reduces acceptable choke current density and core autpick core size
KP and INDUCTANCE					
KP_TARGET			0.60		Target ripple to peak inductor current ratio at the peak of VACMIN. Affects inductance value
LPFC_TARGET (0 bias)			1109	uH	PFC inductance required to hit KP_TARGET at peak of VACMIN and full load
LPFC_DESIRED (0 bias)	998		998	uH	LPFC value used for calculations. Leave blank to use LPFC_TARGET. Enter value to hold constant (also enter core selection) while changing VACMIN to examine brownout operation. Calculated inductance with rounded (integral) turns for powder core.
KP_ACTUAL			0.648		Actual KP calculated from LPFC_DESIRED
LPFC_PEAK			998	uH	Inductance at VACMIN and maximum bias current. For Ferrite, same as LPFC_DESIRED (0 bias)
Basic current parameters					
IAC_RMS			1.45	A	AC input RMS current at VACMIN and Full Power load
IO_DC			0.33	A	Output average current/Average diode



					current
PFS Parameters					
PFS Package	C		C		HiperPFS package selection
PFS Part Number	PFS7628C	Warning	PFS7628C		Peak power rating for the device has been exceeded. Output might droop. Change the input voltage range or select a larger device.
Operating Mode	Full Power		Full Power		Mode of operation of PFS. For Full Power mode enter "Full Power" otherwise enter "EFFICIENCY" to indicate efficiency mode
IOCP min			3.15	A	Minimum Current limit
IOCP typ			3.33	A	Typical current limit
IOCP max			3.47	A	Maximum current limit
IP			3.02	A	MOSFET peak current
IRMS			1.28	A	PFS MOSFET RMS current
RDSON			0.39	Ohms	Typical RDson at 100 °C
FS_PK			47.3	kHz	Estimated frequency of operation at crest of input voltage (at VACMIN)
FS_AVG			39.1	kHz	Estimated average frequency of operation over line cycle (at VACMIN)
PCOND_LOSS_PFS			0.637	W	Estimated PFS conduction losses
PSW_LOSS_PFS			0.866	W	Estimated PFS switching losses
PFS_TOTAL			1.503	W	Total Estimated PFS losses
TJ Max			100	deg C	Maximum steady-state junction temperature
Rth-JS			2.80	°C/W	Maximum thermal resistance (Junction to heatsink)
HEATSINK Theta-CA			37.12	°C/W	Maximum thermal resistance of heatsink
INDUCTOR DESIGN					
Basic Inductor Parameters					
LPFC (0 Bias)			998	uH	Value of PFC inductor at zero current. This is the value measured with LCR meter. For powder, it will be different than LPFC.
LP_TOL			10.0	%	Tolerance of PFC Inductor Value (ferrite only)
IL_RMS			1.52	A	Inductor RMS current (calculated at VACMIN and Full Power Load)
Material and Dimensions					
Core Type	Ferrite		Ferrite		Enter "Sendust", "Iron Powder" or "Ferrite"
Core Material	Auto		PC44/PC95		Select from 60u, 75u, 90u or 125 u for Sendust cores. Fixed at PC44/PC95 for Ferrite cores. Fixed at -52 material for Pow Iron cores.
Core Geometry	EQ		EQ		Toroid only for Sendust and Powdered Iron; EE or PQ for Ferrite cores.
Core	Auto		EQ30		Core part number
Ae			108.00	mm ²	Core cross sectional area
Le			46.00	mm	Core mean path length
AL			3900.00	nH/t ²	Core AL value
Ve			4.97	cm ³	Core volume
HT (EE/PQ/EQ/RM/POT) / ID (toroid)			6.35	mm	Core height/Height of window; ID if toroid
MLT			60.4	mm	Mean length per turn
BW			8.40	mm	Bobbin width
LG			0.72	mm	Gap length (Ferrite cores only)
Flux and MMF calculations					
BP_TARGET (ferrite only)	4400	Info	4400	Gauss	Info: Peak flux density is too high. Check for Inductor saturation during line transient operation
B_OCP (or BP)		Warning	4355	Gauss	Warning: Peak flux density is too high. Check for Inductor saturation during load steps
B_MAX			3443	Gauss	Peak flux density at AC peak, VACMIN and Full Power Load, nominal inductance, minimum IOCP
μ_TARGET (powder)			N/A	%	target μ at peak current divided by μ at zero

only)					current, at VACMIN, full load (powder only) - drives auto core selection
μ _MAX (powder only)			N/A	%	actual μ at peak current divided by μ at zero current, at VACMIN, full load (powder only)
μ _OCP (powder only)			N/A	%	μ at IOCPtyp divided by μ at zero current
I_TEST			3.3	A	Current at which B_TEST and H_TEST are calculated, for checking flux at a current other than IOCP or IP; if blank IOCP_typ is used.
B_TEST			4179	Gauss	Flux density at I_TEST and maximum tolerance inductance
μ _TEST (powder only)			N/A	%	μ at IOCP divided by μ at zero current, at IOCPtyp
Wire					
TURNS			81		Inductor turns. To adjust turns, change BP_TARGET (ferrite) or μ _TARGET (powder)
ILRMS			1.52	A	Inductor RMS current
Wire type	Magnet		Magnet		Select between "Litz" or "Magnet" for double coated magnet wire
AWG	28	Info	28	AWG	Selected wire has increased losses due to skin and proximity effects. Consider using multiple strands of thinner wires, Litz wire, or decreasing the number of layers
Filar	4		4		Inductor wire number of parallel strands. Leave blank to auto-calc for Litz
OD (per strand)			0.320	mm	Outer diameter of single strand of wire
OD bundle (Litz only)			N/A	mm	Will be different than OD if Litz
DCR			0.339	ohm	Choke DC Resistance
P AC Resistance Ratio		Info	5.76		AC resistance is high. Check copper loss, use Litz or thinner wire and fewer layers, or reduce Kp
J			4.73	A/mm ²	Estimated current density of wires. It is recommended that 4 < J < 6
FIT			62	%	Percentage fill of winding window for EE/PQ core. Full window approx. 90%
Layers			14.88		Estimated layers in winding
Loss calculations					
BAC-p-p			2231	Gauss	Core AC peak-peak flux excursion at VACMIN, peak of sine wave
LPFC_CORE_LOSS			0.104	W	Estimated Inductor core Loss
LPFC_COPPER_LOSS		Info	4.529	W	Info: Copper loss too high. Adjust wire gauge and/or filar, being mindful of AC Resistance ratio
LPFC_TOTAL_LOSS			4.633	W	Total estimated Inductor Losses
External PFC Diode					
PFC Diode Part Number	LQA03TC600		LQA03TC600		PFC Diode Part Number
Type			Qspeed		PFC Diode Type / Part Number
Manufacturer			PI		Diode Manufacturer
VRRM			600.0	V	Diode rated reverse voltage
IF			3.00	A	Diode rated forward current
Qrr			17.5	nC	Qrr at High Temperature
VF			2.30	V	Diode rated forward voltage drop
PCOND_DIODE			0.800	W	Estimated Diode conduction losses
PSW_DIODE			0.032	W	Estimated Diode switching losses
P_DIODE			0.832	W	Total estimated Diode losses
TJ Max			100.0	deg C	Maximum steady-state operating temperature
Rth-JS			3.85	degC/W	Maximum thermal resistance (Junction to heatsink)
HEATSINK Theta-CA			67.78	degC/W	Maximum thermal resistance of heatsink
IFSM			30.0	A	Non-repetitive peak surge current rating. Consider larger size diode if inrush or thermal limited.
Output Capacitor					



CO _{UT}	68		68	uF	Minimum value of Output capacitance
VO_RIPPLE_EXPECTED			16.6	V	Expected ripple voltage on Output with selected Output capacitor
T_HOLDUP_EXPECTED			15.2	ms	Expected holdup time with selected Output capacitor
ESR_LF			2.93	ohms	Low Frequency Capacitor ESR
ESR_HF		Warning	1.17	ohms	High frequency ESR must be between 0.01 and 1 ohms
IC_RMS_LF			0.25	A	Low Frequency Capacitor RMS current
IC_RMS_HF			0.70	A	High Frequency Capacitor RMS current
CO_LF_LOSS			0.183	W	Estimated Low Frequency ESR loss in Output capacitor
CO_HF_LOSS			0.568	W	Estimated High frequency ESR loss in Output capacitor
Total CO LOSS			0.751	W	Total estimated losses in Output Capacitor
Input Bridge (BR1) and Fuse (F1)					
I ^{^2} t Rating			5.22	A ² *s	Minimum I ^{^2} t rating for fuse
Fuse Current rating			2.36	A	Minimum Current rating of fuse
VF			0.90	V	Input bridge Diode forward Diode drop
I _{AVG}			1.47	A	Input average current at 70 VAC.
PIV_INPUT BRIDGE			392	V	Peak inverse voltage of input bridge
PCOND_LOSS_BRIDGE			2.353	W	Estimated Bridge Diode conduction loss
CIN			0.47	uF	Input capacitor. Use metallized polypropylene or film foil type with high ripple current rating
RT1			9.79	ohms	Input Thermistor value
D_Precharge			1N5407		Recommended precharge Diode
PFS4 small signal components					
C_REF			1.0	uF	REF pin capacitor value
RV1			4.0	MOhms	Line sense resistor 1
RV2			6.0	MOhms	Line sense resistor 2
RV3			6.0	MOhms	Typical value of the lower resistor connected to the V-PIN. Use 1% resistor only!
RV4			151.7	kOhms	Description pending, could be modified based on feedback chain R1-R4
C_V			0.527	nF	V pin decoupling capacitor (RV4 and C_V should have a time constant of 80us) Pick the closest available capacitance.
C_VCC			1.0	uF	Supply decoupling capacitor
C_C			100	nF	Feedback C pin decoupling capacitor
Power good Vo lower threshold VPG(L)			333	V	Vo lower threshold voltage at which power good signal will trigger
PGT set resistor			312.7	kohm	Power good threshold setting resistor
Feedback Components					
R1			4.00	Mohms	Feedback network, first high voltage divider resistor
R2			6.00	Mohms	Feedback network, second high voltage divider resistor
R3			6.00	Mohms	Feedback network, third high voltage divider resistor
R4			151.7	kohms	Feedback network, lower divider resistor
C1			0.527	nF	Feedback network, loop speedup capacitor. (R4 and C1 should have a time constant of 80us) Pick the closest available capacitance.
R5			22.1	kohms	Feedback network: zero setting resistor
C2			1000	nF	Feedback component- noise suppression capacitor
Loss Budget (Estimated at VACMIN)					
PFS Losses			1.508	W	Total estimated losses in PFS
Boost diode Losses			0.832	W	Total estimated losses in Output Diode
Input Bridge losses			2.353	W	Total estimated losses in input bridge module
Input Capacitor Losses			0.005	W	Total estimated losses in input capacitor
Inductor losses			4.633	W	Total estimated losses in PFC choke
Output Capacitor Loss			0.751	W	Total estimated losses in Output capacitor

EMI choke copper loss			0.211	W	Total estimated losses in EMI choke copper
Total losses			10.292	W	Overall loss estimate
Efficiency			0.93		Estimated efficiency at VACMIN, full load.
CAPZero component selection recommendation					
CAPZero Device			CAP200DG		(Optional) Recommended CAPZero device to discharge X-Capacitor with time constant of 1 second
Total Series Resistance (Rcapzero1+Rcapzero2)			0.730	M-ohms	Maximum Total Series resistor value to discharge X-Capacitors
EMI filter components recommendation					
CIN_RECOMMENDED			470	nF	Metallized polyester film capacitor after bridge, ratio with Po
CX2			470	nF	X capacitor after differential mode choke and before bridge, ratio with Po
LDM_calc			270	uH	estimated minimum differential inductance to avoid <10kHz resonance in input current
CX1			470	nF	X capacitor before common mode choke, ratio with Po
LCM			10	mH	typical common mode choke value
LCM_leakage			30	uH	estimated leakage inductance of CM choke, typical from 30~60uH
CY1 (and CY2)			220	pF	typical Y capacitance for common mode noise suppression
LDM_Actual			240	uH	cal_LDM minus LCM_leakage, utilizing CM leakage inductance as DM choke.
DCR_LCM			0.070	Ohms	total DCR of CM choke for estimating copper loss
DCR_LDM			0.030	Ohms	total DCR of DM choke(or CM #2) for estimating copper loss
Note: CX2 can be placed between CM chock and DM choke depending on EMI design requirement.					

Note: All warnings were verified on actual bench tests and passed the criteria specified on the spreadsheet.

9.2 **LYTSwitch-6 Design Spreadsheet**

DCDC_LYTSwitch6_Flyback_040419; Rev.1.0; Copyright Power Integrations 2019	INPUT	INFO	OUTPUT	UNITS	DCDC LYTSwitch6 Flyback Design Spreadsheet
APPLICATION VARIABLES					
VDCIN_MIN	400		385	V	Minimum input DC voltage
VDCIN_MAX	420		420	V	Maximum input DC voltage
VOUT	48.00		42.00	V	Output voltage
IOUT	2.100		3.000	A	Output current
POUT		Info	126.00	W	The specified output current exceeds the device power capability: verify thermal performance
EFFICIENCY			0.95		DC-DC efficiency estimate at full load
FACTOR_Z			0.50		Z-factor estimate
ENCLOSURE	OPEN FRAME		OPEN FRAME		Power supply enclosure
PRIMARY CONTROLLER SELECTION					
ILIMIT_MODE	INCREASED		INCREASED		Device current limit mode
VDRAIN_BREAKDOWN	750		750	V	Device breakdown voltage
DEVICE_GENERIC	LYT6070-H131		LYT6070-H131		Generic device code
DEVICE_CODE			LYT6070C		Actual device code
POUT_MAX			120	W	Power capability of the device based on thermal performance
RDSON_100DEG			0.54	Ω	Primary switch on time drain resistance at 100 degC
ILIMIT_MIN			3.962	A	Minimum current limit of the primary switch
ILIMIT_TYP			4.260	A	Typical current limit of the primary switch
ILIMIT_MAX			4.558	A	Maximum current limit of the primary switch
VDRAIN_ON_PRSW			0.18	V	Primary switch on time drain voltage
VDRAIN_OFF_PRSW			585.0	V	Peak drain voltage on the primary switch during turn-off
WORST CASE ELECTRICAL PARAMETERS					
FSWITCHING_MAX	57000		57000	Hz	Maximum switching frequency at full load and minimum DC input voltage
VOR	95.0		95.0	V	Secondary voltage reflected to the primary when the primary switch turns off
KP			1.09		Measure of continuous/discontinuous mode of operation
MODE_OPERATION			DCM		Mode of operation
DUTYCYCLE			0.185		Primary switch duty cycle
TIME_ON			3.85	us	Primary switch on-time
TIME_OFF			14.34	us	Primary switch off-time
LPRIMARY_MIN			335.5	uH	Minimum primary inductance
LPRIMARY_TYP			353.2	uH	Typical primary inductance
LPRIMARY_TOL	5.0		5.0	%	Primary inductance tolerance
LPRIMARY_MAX			370.9	uH	Maximum primary inductance
PRIMARY CURRENTS					
IPEAK_PRIMARY			4.062	A	Primary switch peak current
IPEDESTAL_PRIMARY			0.000	A	Primary switch current pedestal
I AVG_PRIMARY			0.336	A	Primary switch average current
IRIPPLE_PRIMARY			4.062	A	Primary switch ripple current
IRMS_PRIMARY			0.954	A	Primary switch RMS current
SECONDARY CURRENTS					
IPEAK_SECONDARY			9.374	A	Secondary winding peak current
IPEDESTAL_SECONDARY			0.000	A	Secondary winding current pedestal

IRMS_SECONDARY			4.431	A	Secondary winding RMS current
IRIPPLE_CAP_OUT					
TRANSFORMER CONSTRUCTION PARAMETERS					
CORE SELECTION					
CORE	PQ26/25	Info	PQ26/25		The transformer windings may not fit: pick a bigger core or bobbin and refer to the Transformer Parameters tab for fit calculations
CORE CODE			B65877A0000 R095		Core code
AE			122.00	mm ²	Core cross sectional area
LE			53.60	mm	Core magnetic path length
AL			5700	nH/turns ²	Ungapped core effective inductance
VE			6530.0	mm ³	Core volume
BOBBIN			B65878E1012 D001		Bobbin
AW			47.00	mm ²	Window area of the bobbin
BW			12.70	mm	Bobbin width
MARGIN			0.0	mm	Safety margin width (Half the primary to secondary creepage distance)
PRIMARY WINDING					
NPRIMARY			30		Primary turns
BPEAK		Warning	4727	Gauss	The peak flux density of the core has exceeded the saturation flux density: Increase the number of secondary turns
BMAX		Warning	4050	Gauss	The maximum flux density of the core has exceeded the saturation flux density: Increase the number of secondary turns
BAC			2025	Gauss	AC flux density (0.5 x Peak to Peak)
ALG			392	nH/turns ²	Typical gapped core effective inductance
LG			0.364	mm	Core gap length
LAYERS_PRIMARY	2		2		Number of primary layers
AWG_PRIMARY	27		27	AWG	Primary winding wire AWG
OD_PRIMARY_INSULATED			0.418	mm	Primary winding wire outer diameter with insulation
OD_PRIMARY_BARE			0.361	mm	Primary winding wire outer diameter without insulation
CMA_PRIMARY			211	Cmil/A	Primary winding wire CMA
PRIMARY BIAS WINDING					
NBIAS_PRIMARY			8		Primary bias turns
SECONDARY WINDING					
NSECONDARY	13		13		Secondary turns
AWG_SECONDARY	20		20	AWG	Secondary winding wire AWG
OD_SECONDARY_INSULATED			1.118	mm	Secondary winding wire outer diameter with insulation
OD_SECONDARY_BARE			0.812	mm	Secondary winding wire outer diameter without insulation
CMA_SECONDARY			231	Cmil/A	Secondary winding wire CMA
SECONDARY BIAS WINDING					
NBIAS_SECONDARY			5		Secondary bias turns (Required only for VOUT>24V or VOUT<4.4V)
PRIMARY COMPONENTS SELECTION					
LINE UNDERVOLTAGE					
OV_REQUIRED			428.4	V	Required DC over-voltage threshold
OV_ACTUAL			430.2	V	Actual DC over-voltage threshold
RLS			3.64	MΩ	Connect two 1.82 MOhm resistors to the V-pin for the required UV/OV threshold
BROWN-IN_ACTUAL			96.6	V	Actual DC brown-in threshold
BROWN-OUT_ACTUAL			93.4	V	Actual DC brown-out threshold
PRIMARY BIAS WINDING DIODE					
VBIAS_PRIMARY	24.0		24.0	V	Rectified bias voltage
VF_BIAS_PRIMARY			0.70	V	Secondary bias winding diode forward



VREVERSE_PRIBIASDIODE_PRIMARY			136.00	V	drop Primary bias diode reverse voltage (not accounting parasitic voltage ring)
CBIAS_PRIMARY			22	uF	Primary bias winding rectification capacitor
CBPP			0.47	uF	BPP pin capacitor
SECONDARY COMPONENTS					
FEEDBACK					
RFB_UPPER	510.00		510.00	kΩ	Upper feedback resistor (connected to the first output voltage)
RFB_LOWER			15.80	kΩ	Lower feedback resistor
CFB_LOWER			330	pF	Lower feedback resistor decoupling capacitor
RECTIFIER					
VREVERSE_RECTIFIER			224.0		Secondary rectifier reverse voltage (not accounting parasitic voltage ring)
TYPE_RECTIFIER	AUTO		DIODE		Type of secondary rectifier used
RECTIFIER	AUTO		STTH3R04		Secondary rectifier
VF_RECTIFIER			1.500		Secondary rectifier forward voltage drop
BVDSS_RECTIFIER			400		Breakdown voltage of the secondary rectifier
RDSON_RECTIFIER			NA		On-time drain to source resistance of the secondary rectifier
TRR_RECTIFIER			18.0		Reverse recovery time of the ultra-fast diode
SECONDARY BIAS WINDING DIODE					
VBIAS_SECONDARY	20		20	V	Rectified secondary bias voltage
VBIAS_SECONDARY	24		24	V	Rectified secondary bias voltage
VF_BIAS_SECONDARY			0.7	V	Secondary bias winding diode forward drop
VREVERSE_BIASDIODE_SECONDARY			136.00	V	Secondary bias diode reverse voltage (not accounting parasitic voltage ring)
TOLERANCE ANALYSIS					
USER_VDC			403	V	Input DC voltage corner to be evaluated
USER_ILIMIT	TYP		4.260	A	Current limit corner to be evaluated
USER_LPRIMARY	TYP		353.2	uH	Primary inductance corner to be evaluated
MODE_OPERATION			DCM		Mode of operation
KP			1.177		Measure of continuous/discontinuous mode of operation
FSWITCHING			49511	Hz	Switching frequency at full load and valley of the rectified minimum AC input voltage
DUTYCYCLE			0.167		Steady state duty cycle
TIME_ON			3.38	us	Primary switch on-time
TIME_OFF			16.82	us	Primary switch off-time
IPEAK_PRIMARY			3.846	A	Primary switch peak current
IPEDESTAL_PRIMARY			0.000	A	Primary switch current pedestal
IAVERAGE_PRIMARY			0.321	A	Primary switch average current
IRIPPLE_PRIMARY			3.846	A	Primary switch ripple current
IRMS_PRIMARY			0.908	A	Primary switch RMS current
BPEAK		Warning	4208	Gauss	The peak flux density of the core has exceeded the saturation flux density: Increase the number of secondary turns
BMAX			3711	Gauss	Maximum flux density
BAC			1856	Gauss	AC flux density (0.5 x Peak to Peak)

Note: All warnings were verified on actual bench tests and passed the criteria specified on the spreadsheet.

10 Heat Sink Assembly

10.1 Heat Sink Fabrication Drawing

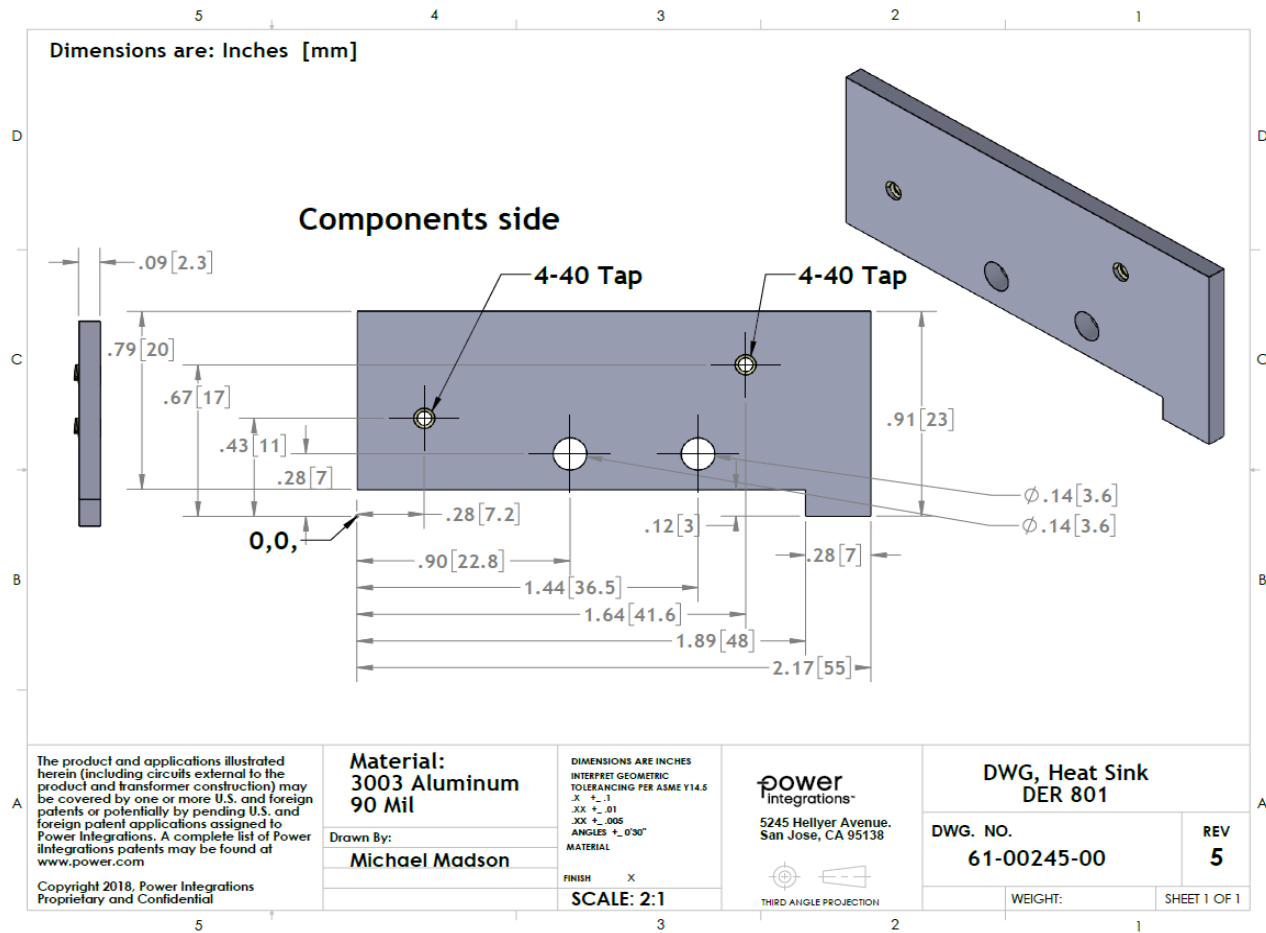

10.2 **Heat Sink Fabrication Drawing**

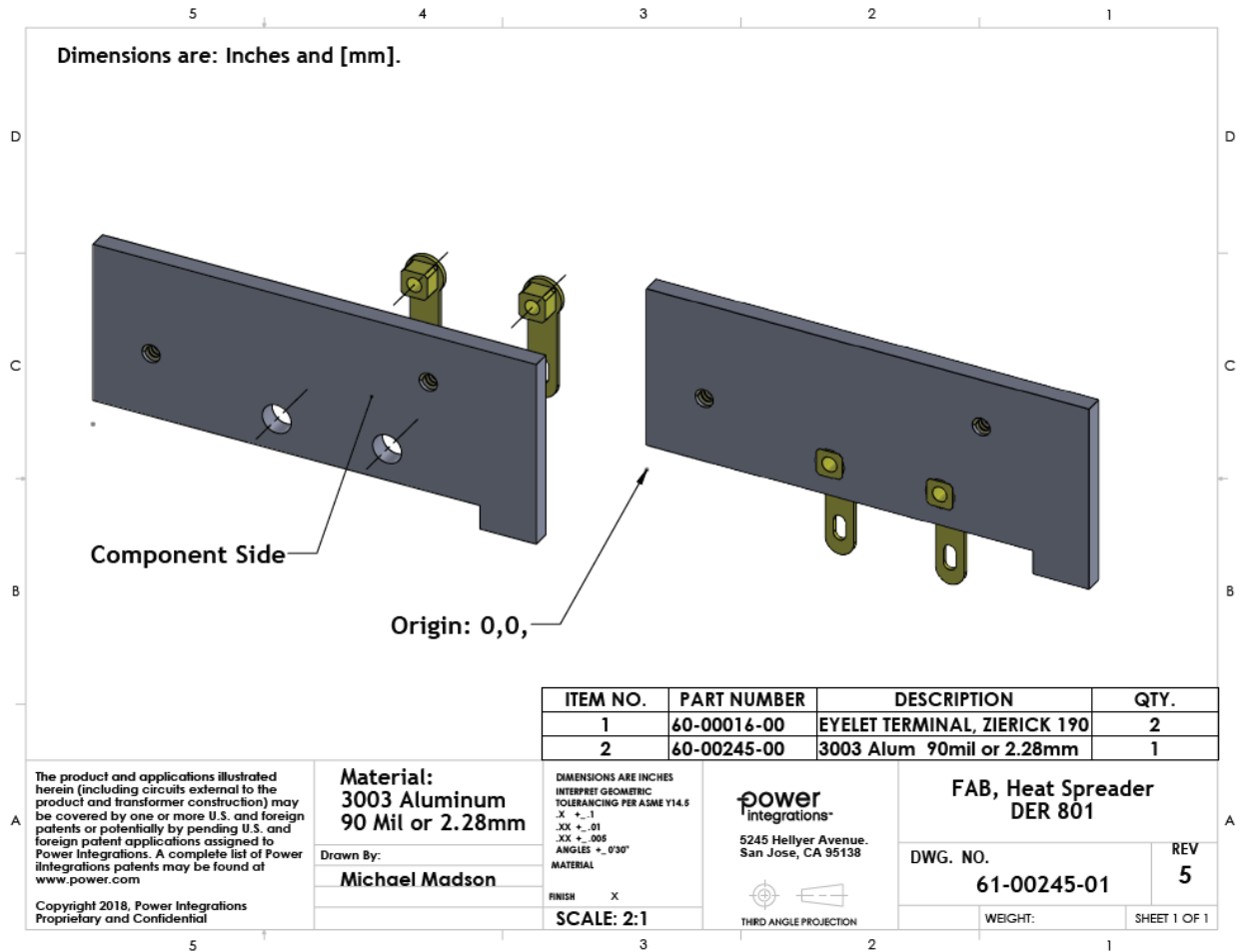

10.3 Heat Sink and Assembly Drawing

Dimensions are: Inches and [mm].

DETAIL A

4-40 Tap

4-40 Tap

4-40 Tap

Assembled Component Side

Assembled Back Side

ITEM NO.	PART NUMBER	DESCRIPTION	QTY.
1	15-00834-00	PFC Diode 600 V, 3 Amp	1
2	75-00164-00	WASHER FLAT #4 ZINC-YCF	2
3	75-0002-00	Machine Screw 4-40 x .3125	1
4	75-00001-00	Machine screw #4-40 x .250	1
5	15-01213-00	Bridge Rectifier 4amp 1000V	1
6	61-00245-01	DER 801 Fabrication	1
7	66-00084-00	Thermal Conductive Grease	2

<p>The product and applications illustrated herein (including circuits external to the product and transformer construction) may be covered by one or more U.S. and foreign patents or potentially by pending U.S. and foreign patent applications assigned to Power Integrations. A complete list of Power Integrations patents may be found at www.power.com</p> <p>Copyright 2018, Power Integrations Proprietary and Confidential</p>	<p>Material: 3003 Aluminum 90 Mil or 2.28mm</p>	<p>DIMENSIONS ARE INCHES INTERPRET GEOMETRIC TOLERANCING PER ASME Y14.5 .X +.1 .XX +.01 .XXX +.005 ANGLES +.030"</p>	<p>power integrations 5245 Hellyer Avenue. San Jose, CA 95138</p>	<p>Assbly, Heat Sink DER 801</p>	
	<p>Drawn By: Michael Madson</p>	<p>FINISH X</p>	<p>THIRD ANGLE PROJECTION</p>	<p>DWG. NO. 61-00245-02</p>	<p>REV 5</p>
	<p>SCALE: 2:1</p>	<p>WEIGHT:</p>	<p>SHEET 1 OF 1</p>		



11 Performance Data

All measurements were performed at room temperature at 600 s soak time.

11.1 CV/CC Output Characteristic Curve

CV/CC was measured using CR E-Load for non-dimming application. Output is plotted until the PFC is disabled (high PF).

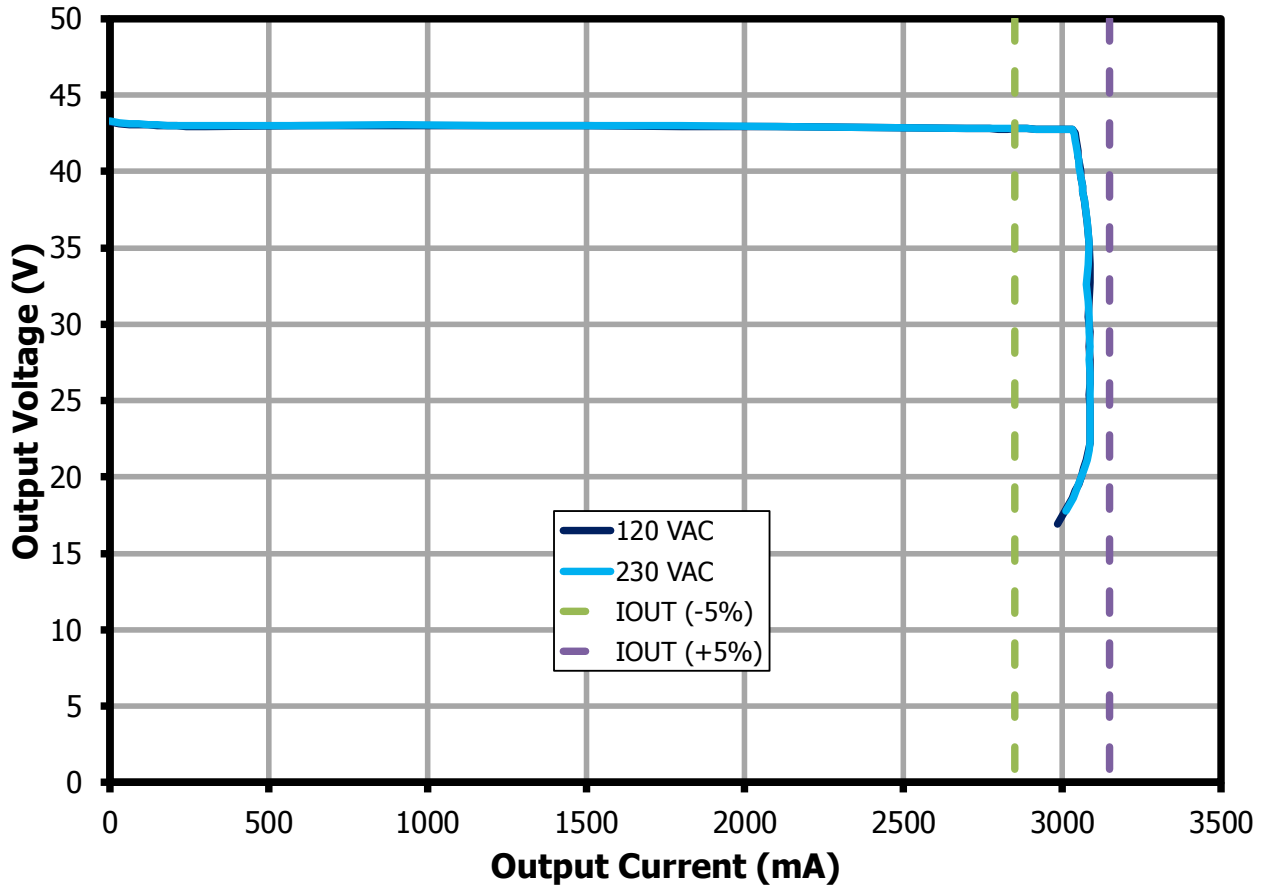

Figure 18 – CV/CC Curve.



11.2 System Efficiency

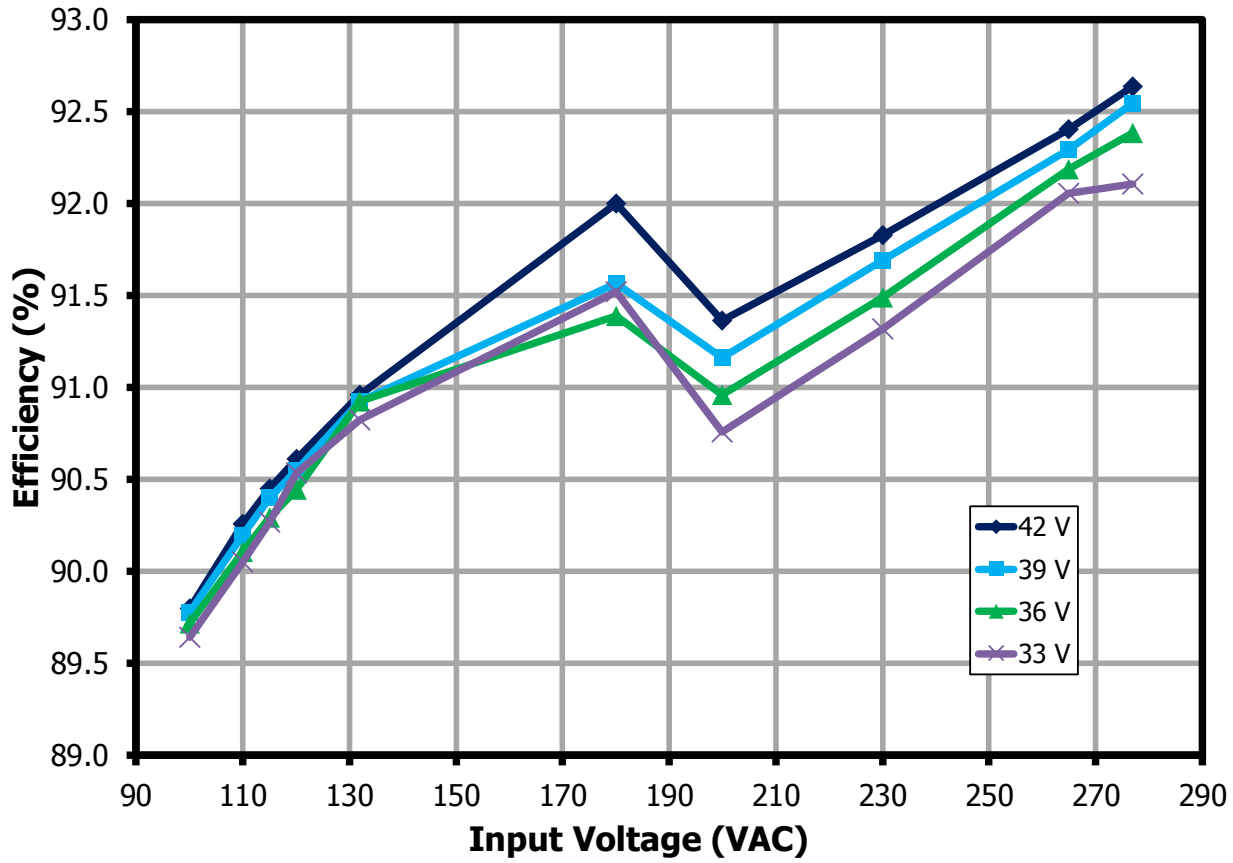

Figure 19 – Efficiency vs. Line and LED Load.

11.3 Output Current Regulation

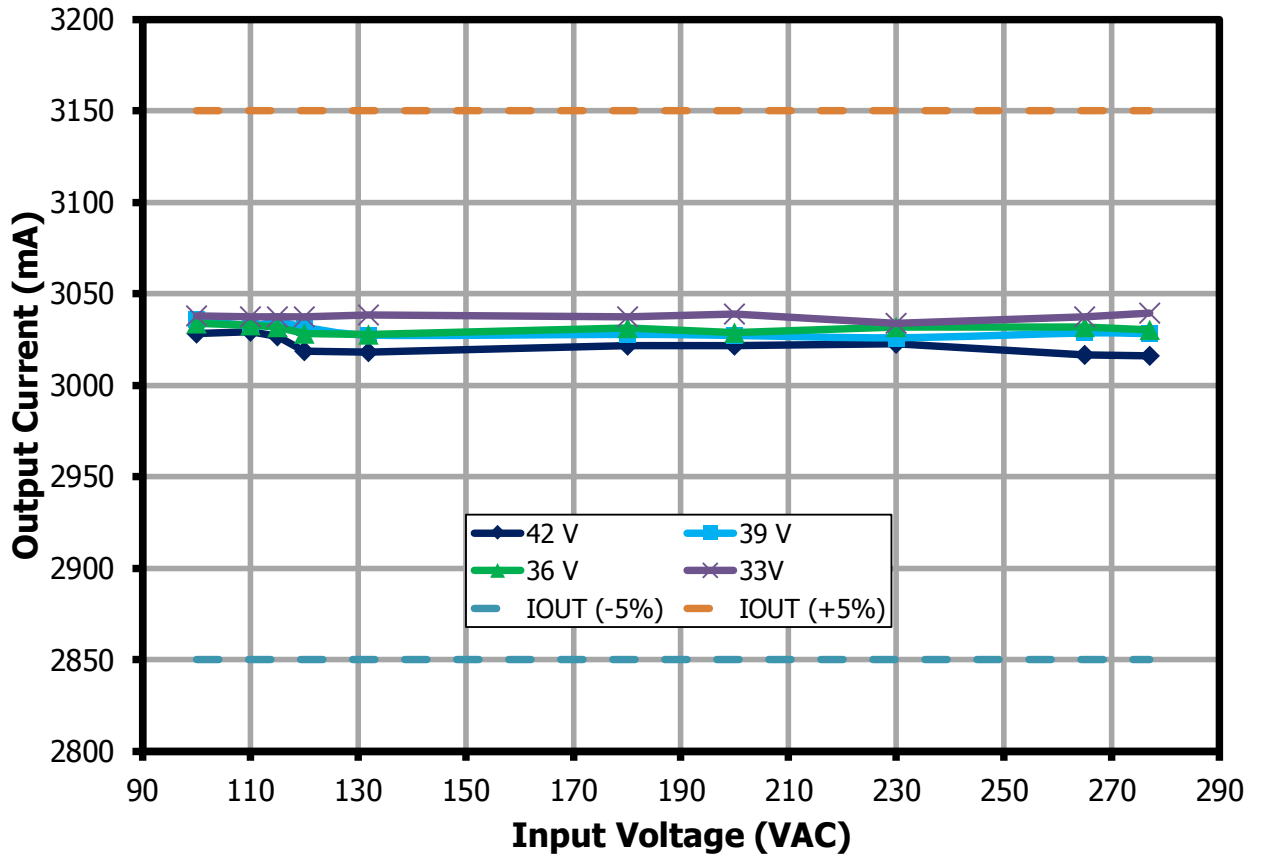

Figure 20 – Current Regulation vs. Line and LED Load.



11.4 **Power Factor**

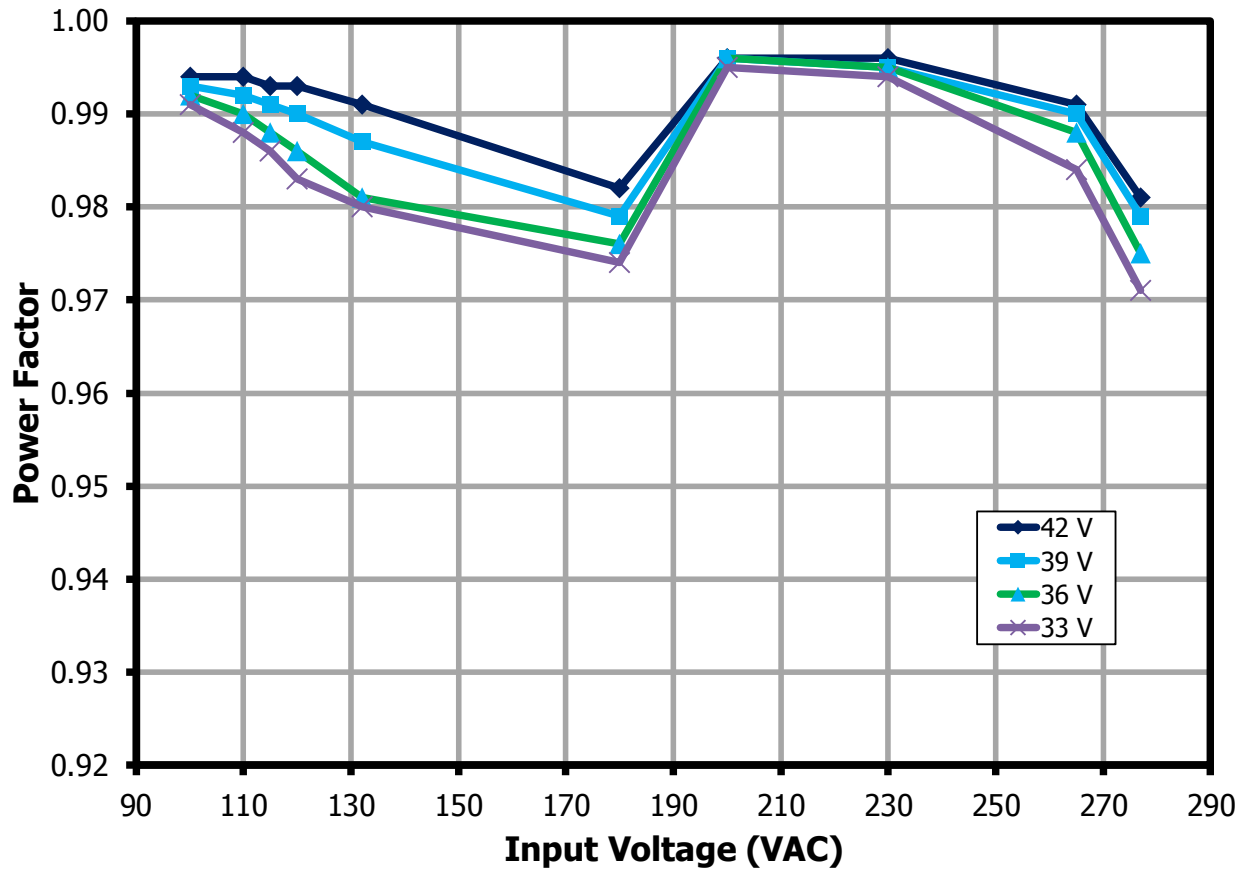

Figure 21 – Power Factor vs. Line and LED Load.

11.5 %ATHD

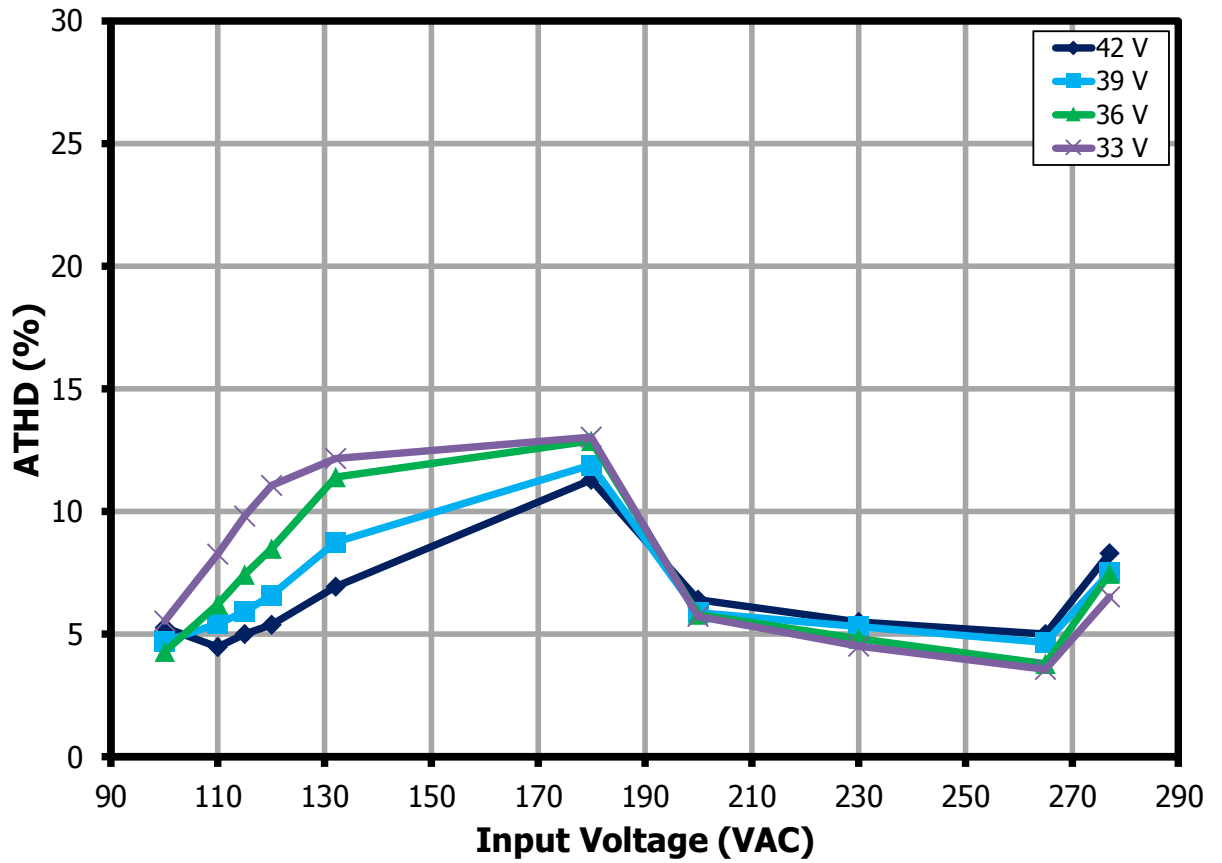

Figure 22 – %ATHD vs. Line and LED Load.



11.6 **Individual Harmonic Content at 42 V LED Load**

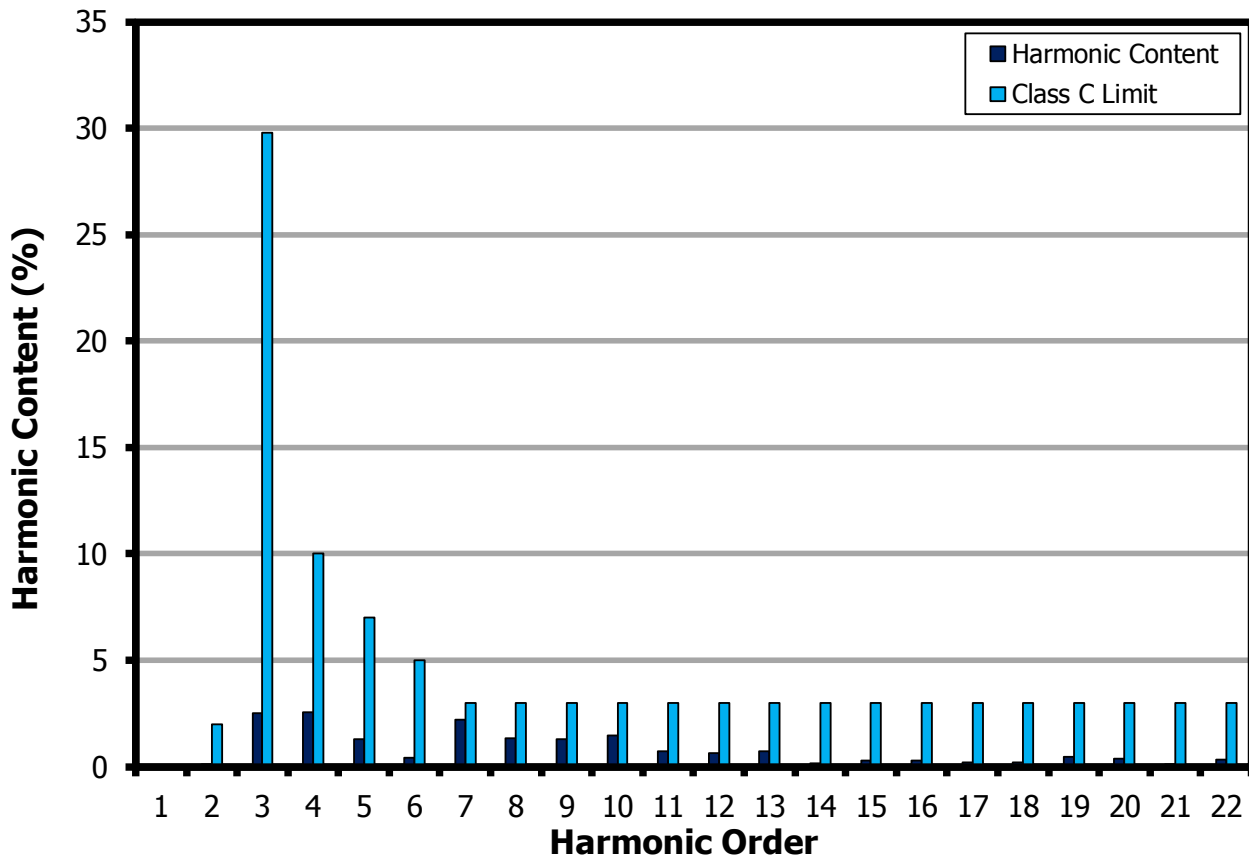

Figure 23 – 42 V LED Load Input Current Harmonics at 120 VAC, 60 Hz.

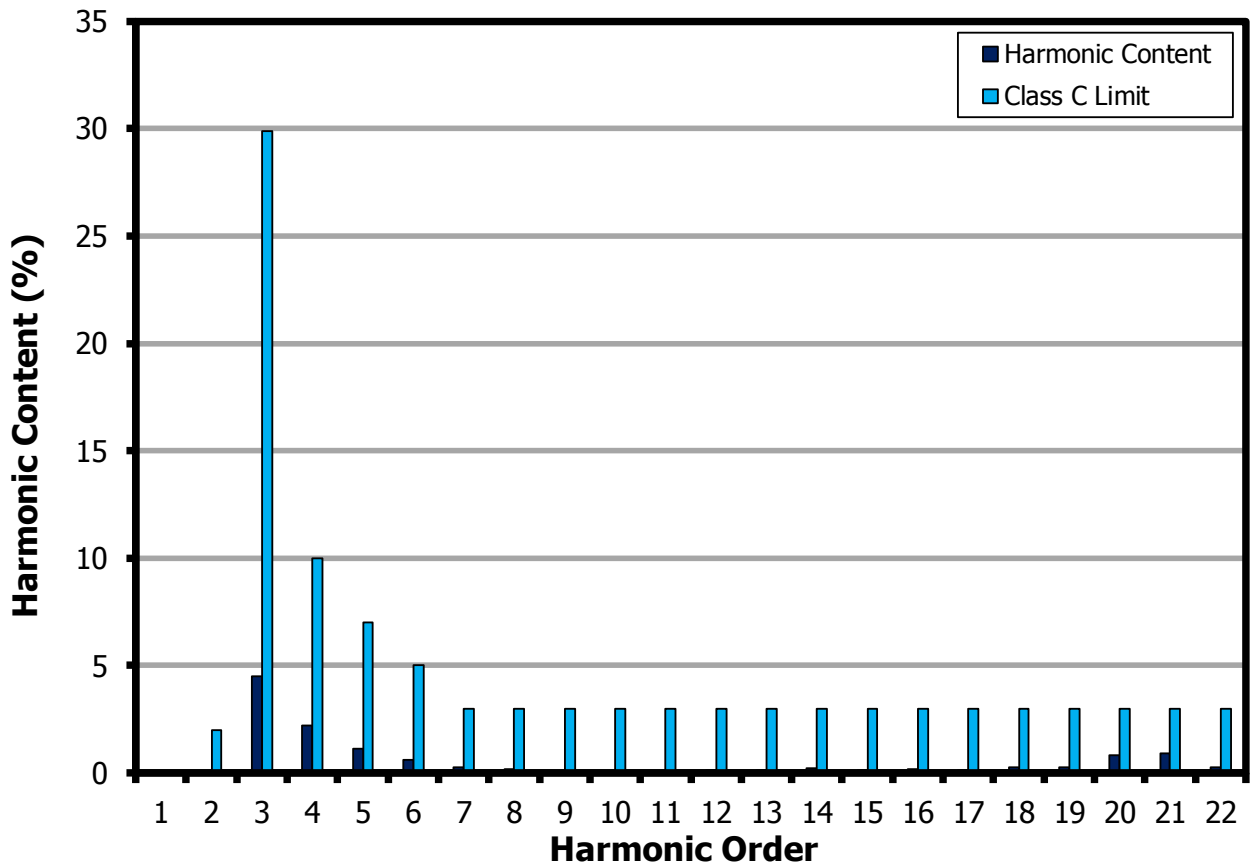

Figure 24 – 42 V LED Load Input Current Harmonics at 230 VAC, 50 Hz.



11.7 **No-Load Input Power**

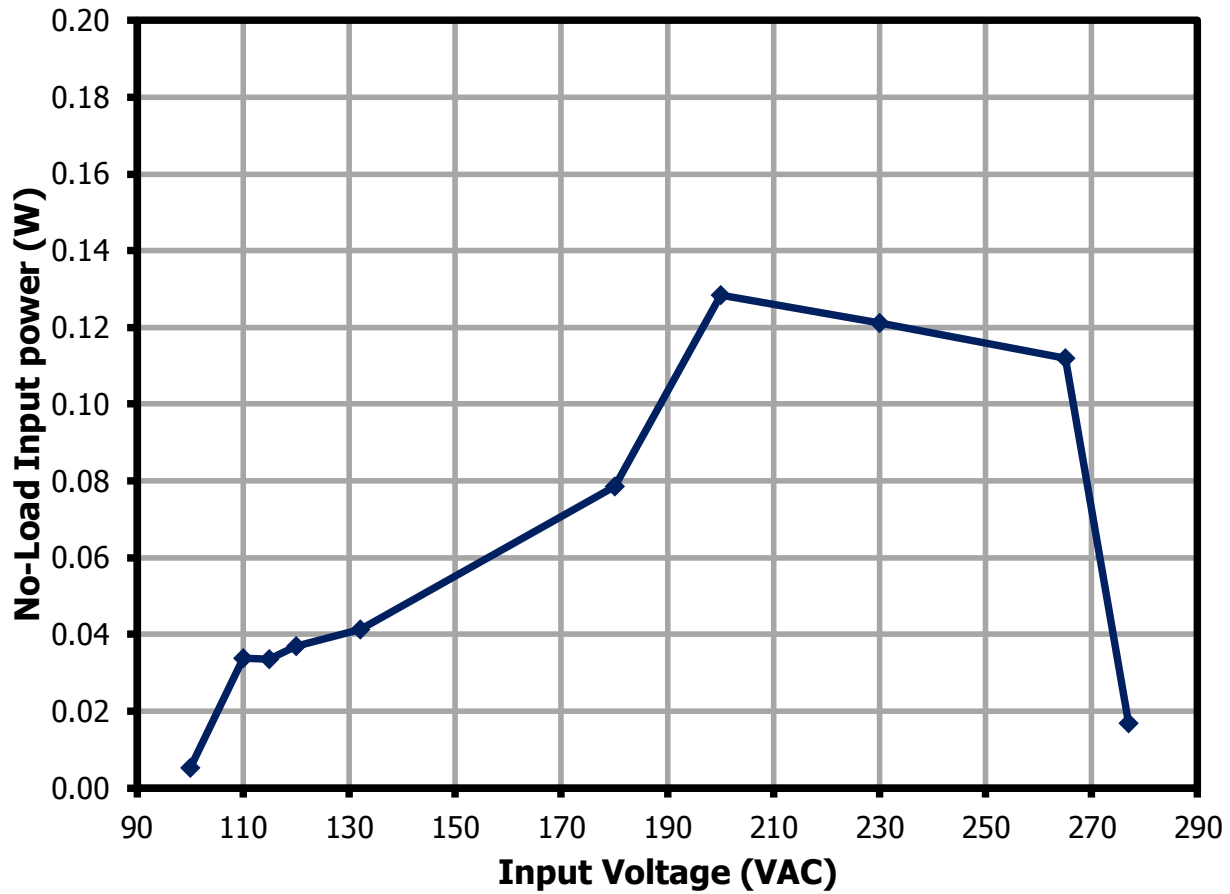

Figure 25 – No-Load Input Power vs. Line.

12 Test Data

12.1 42 V LED Load

Input		Input Measurement					LED Load Measurement			Efficiency (%)
VAC (V _{RMS})	Freq (Hz)	V _{IN} (V _{RMS})	I _{IN} (mA _{RMS})	P _{IN} (W)	PF	%ATHD	V _{OUT} (V _{DC})	I _{OUT} (mA _{DC})	P _{OUT} (W)	
100	60	99.55	1435.6	142.06	0.994	5.28	42.12	3028.5	127.57	89.80
110	60	109.49	1298.9	141.35	0.994	4.47	42.12	3029.3	127.58	90.26
115	60	114.56	1238.2	140.91	0.993	4.99	42.11	3026.8	127.45	90.45
120	60	119.53	1181.9	140.24	0.993	5.39	42.09	3018.8	127.07	90.61
132	60	131.62	1071.2	139.64	0.991	6.94	42.09	3018.1	127.02	90.96
180	50	179.7	783.6	138.24	0.982	11.29	42.09	3021.8	127.18	92.00
200	50	199.75	699.7	139.19	0.996	6.41	42.09	3021.7	127.17	91.36
230	50	229.81	605.4	138.54	0.996	5.50	42.09	3022.9	127.22	91.83
265	50	264.86	523.4	137.35	0.991	4.99	42.08	3016.4	126.92	92.41
277	60	276.89	504.3	137	0.981	8.29	42.08	3016.2	126.91	92.64

12.2 39 V LED Load

Input		Input Measurement					LED Load Measurement			Efficiency (%)
VAC (V _{RMS})	Freq (Hz)	V _{IN} (V _{RMS})	I _{IN} (mA _{RMS})	P _{IN} (W)	PF	%ATHD	V _{OUT} (V _{DC})	I _{OUT} (mA _{DC})	P _{OUT} (W)	
100	60	99.58	1339.2	132.38	0.993	4.72	39.15	3036.1	118.85	89.78
110	60	109.55	1211.1	131.58	0.992	5.43	39.13	3032.8	118.68	90.20
115	60	114.61	1156.6	131.36	0.991	5.92	39.13	3034.9	118.75	90.40
120	60	119.59	1106.5	130.99	0.990	6.58	39.12	3031.9	118.61	90.55
132	60	131.69	1002.4	130.23	0.987	8.77	39.11	3027.4	118.41	90.92
180	50	179.68	734.9	129.33	0.979	11.89	39.11	3027.8	118.42	91.56
200	50	199.73	652.8	129.86	0.996	5.87	39.11	3027.2	118.38	91.16
230	50	229.79	564.2	129.04	0.995	5.32	39.10	3025.9	118.32	91.69
265	50	264.84	489.6	128.32	0.990	4.67	39.10	3028.6	118.43	92.29
277	60	276.86	472.2	127.95	0.979	7.51	39.10	3028.2	118.41	92.54

12.3 **36 V LED Load**

Input		Input Measurement					LED Load Measurement			Efficiency (%)
VAC (V _{RMS})	Freq (Hz)	V _{IN} (V _{RMS})	I _{IN} (mA _{RMS})	P _{IN} (W)	PF	%ATHD	V _{OUT} (V _{DC})	I _{OUT} (mA _{DC})	P _{OUT} (W)	
100	60	99.63	1237.7	122.36	0.992	4.30	36.19	3033.8	109.78	89.72
110	60	109.6	1122.7	121.79	0.99	6.21	36.18	3033	109.74	90.11
115	60	114.66	1072	121.47	0.988	7.41	36.18	3031.8	109.68	90.29
120	60	119.64	1026.1	121.09	0.986	8.50	36.17	3028.2	109.52	90.45
132	60	131.73	931.9	120.46	0.981	11.41	36.17	3027.8	109.53	90.93
180	50	179.72	684.6	119.99	0.976	12.89	36.18	3031.3	109.66	91.39
200	50	199.76	605.6	120.45	0.996	5.81	36.18	3028.7	109.56	90.96
230	50	229.82	524.4	119.88	0.995	4.83	36.18	3031.6	109.68	91.49
265	50	264.87	454.8	118.98	0.988	3.81	36.18	3031.6	109.68	92.18
277	60	276.89	439.4	118.67	0.975	7.45	36.18	3030.2	109.63	92.38

12.4 **33 V LED Load**

Input		Input Measurement					LED Load Measurement			Efficiency (%)
VAC (V _{RMS})	Freq (Hz)	V _{IN} (V _{RMS})	I _{IN} (mA _{RMS})	P _{IN} (W)	PF	%ATHD	V _{OUT} (V _{DC})	I _{OUT} (mA _{DC})	P _{OUT} (W)	
100	60	99.64	1137.7	112.37	0.991	5.52	33.16	3037.8	100.73	89.64
110	60	109.61	1033.1	111.85	0.988	8.25	33.16	3037.4	100.72	90.05
115	60	114.67	987.1	111.57	0.986	9.83	33.16	3037.3	100.71	90.27
120	60	119.65	945.4	111.23	0.983	11.05	33.15	3037.5	100.7	90.53
132	60	131.74	859.4	110.9	0.98	12.16	33.15	3038.3	100.72	90.82
180	50	179.73	628.7	110.02	0.974	13.04	33.15	3037.4	100.69	91.52
200	50	199.77	558.4	111.02	0.995	5.74	33.15	3039.2	100.76	90.76
230	50	229.83	482.3	110.13	0.994	4.50	33.15	3034.1	100.57	91.32
265	50	264.87	419.5	109.39	0.984	3.57	33.15	3037.6	100.7	92.06
277	60	276.89	407.1	109.42	0.971	6.52	33.16	3039.6	100.78	92.10

12.5 **No-Load**

Input		Input Measurement		
VAC (V _{RMS})	Freq (Hz)	V _{IN} (V _{RMS})	I _{IN} (mA _{RMS})	P _{IN} (W)
100	60	99.99	30.08	0.005
110	60	109.92	32.43	0.034
115	60	114.97	33.6	0.034
120	60	119.93	34.75	0.037
132	60	131.99	37.26	0.041
180	50	179.9	47.66	0.079
200	50	199.93	45.13	0.128
230	50	229.96	47.08	0.121
265	50	264.98	48.2	0.112
277	60	276.99	52.49	0.017

12.6 **Individual Harmonic Content at 120 VAC and 42 V LED Load**

V_{IN} (V_{RMS})	Freq (Hz)	I_{IN} (mA_{RMS})	P_{IN} (W)	PF	%THD
119.58	60	1192.50	141.55	0.99	5.65
Harmonic Content			Class C Limit		
nth Order	mA Content	% Content	mA Limit <25 W	% Limit >25 W	Remarks
1	1191.2				
2	1.1	0.09		2	pass
3	30.1	2.53	481.27	29.79	pass
5	30.2	2.54	268.95	10	pass
7	15.4	1.29	141.55	7	pass
9	4.8	0.40	70.78	5	pass
11	26.3	2.21	49.54	3	pass
13	16	1.34	41.92	3	pass
15	15.2	1.28	36.33	3	pass
17	17.6	1.48	32.06	3	pass
19	8.4	0.71	28.68	3	pass
21	7.6	0.64	25.95	3	pass
23	8.5	0.71	23.69	3	pass
25	1.7	0.14	21.80	3	pass
27	3.2	0.27	20.18	3	pass
29	3.4	0.29	18.79	3	pass
31	2.5	0.21	17.58	3	pass
33	2.3	0.19	16.51	3	pass
35	5.5	0.46	15.57	3	pass
37	4.2	0.35	14.73	3	pass
39	1.2	0.10	13.97	3	pass

12.7 **Individual Harmonic Content at 230 VAC and 42 V LED Load**

V_{IN} (V_{RMS})	Freq (Hz)	I_{IN} (mA_{RMS})	P_{IN} (W)	PF	%THD
229.82	50	604.20	138.28	1.00	5.41
Harmonic Content			Class C Limit		
nth Order	mA Content	% Content	mA Limit <25 W	% Limit >25 W	Remarks
1	601.6				
2	0.2	0.03		2	pass
3	27	4.49	470.15	29.88	pass
5	13.3	2.21	262.73	10	pass
7	6.7	1.11	138.28	7	pass
9	3.7	0.62	69.14	5	pass
11	1.5	0.25	48.40	3	pass
13	1.2	0.20	40.95	3	pass
15	0.3	0.05	35.49	3	pass
17	0.4	0.07	31.32	3	pass
19	0.6	0.10	28.02	3	pass
21	0.7	0.12	25.35	3	pass
23	0.8	0.13	23.15	3	pass
25	1.4	0.23	21.30	3	pass
27	0.9	0.15	19.72	3	pass
29	1	0.17	18.36	3	pass
31	0.8	0.13	17.17	3	pass
33	1.6	0.27	16.13	3	pass
35	1.5	0.25	15.21	3	pass
37	5.1	0.85	14.39	3	pass
39	5.6	0.93	13.65	3	pass

13 Dimming Performance

Dimming performance data were taken at room temperature.

13.1 Dimming Curve

13.1.1 0 V - 10 V Dimming Curve

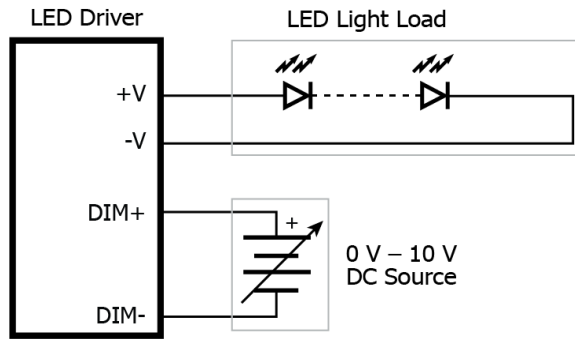

PI-8489-101117

Figure 26 – 0 V- 10 V Dimming Set-up.

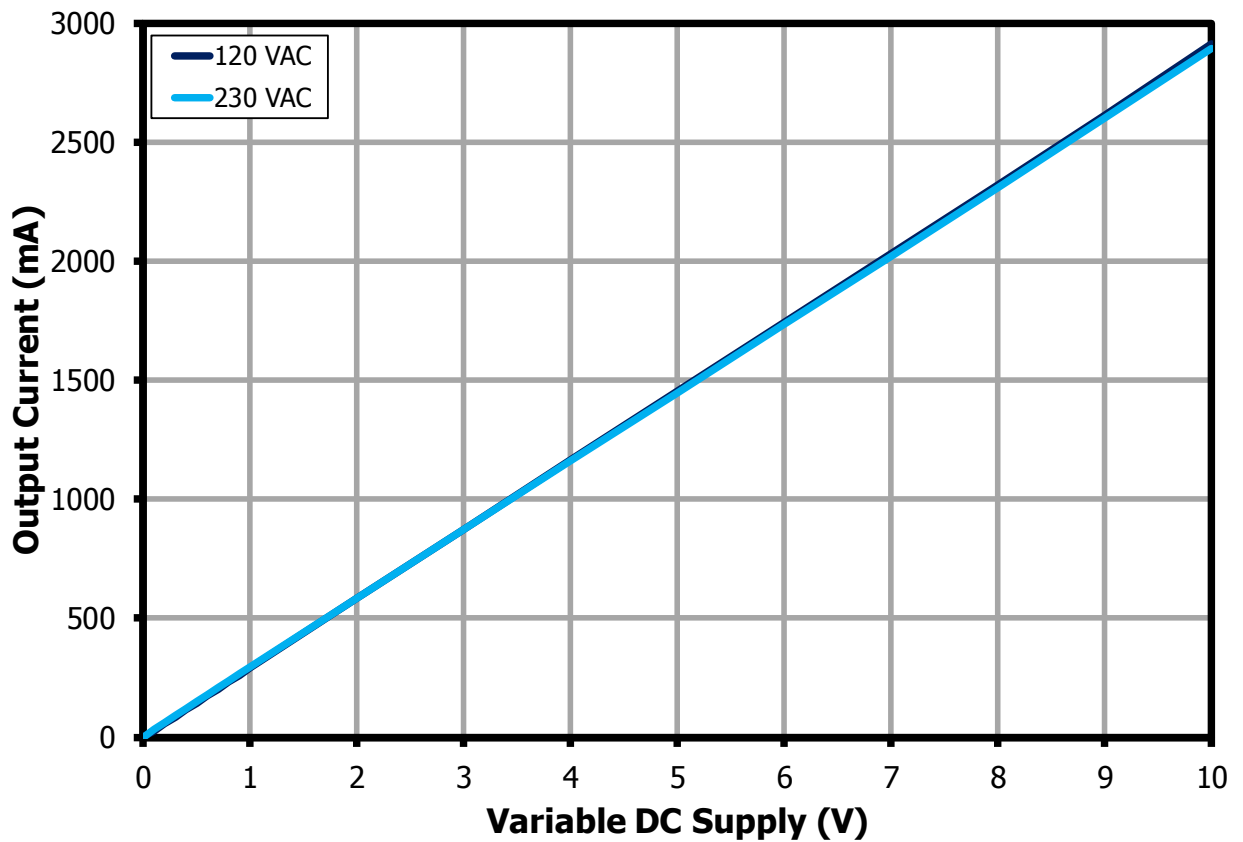

Figure 27 – 0 V - 10 V Dimming Curve at 42 V LED Load.



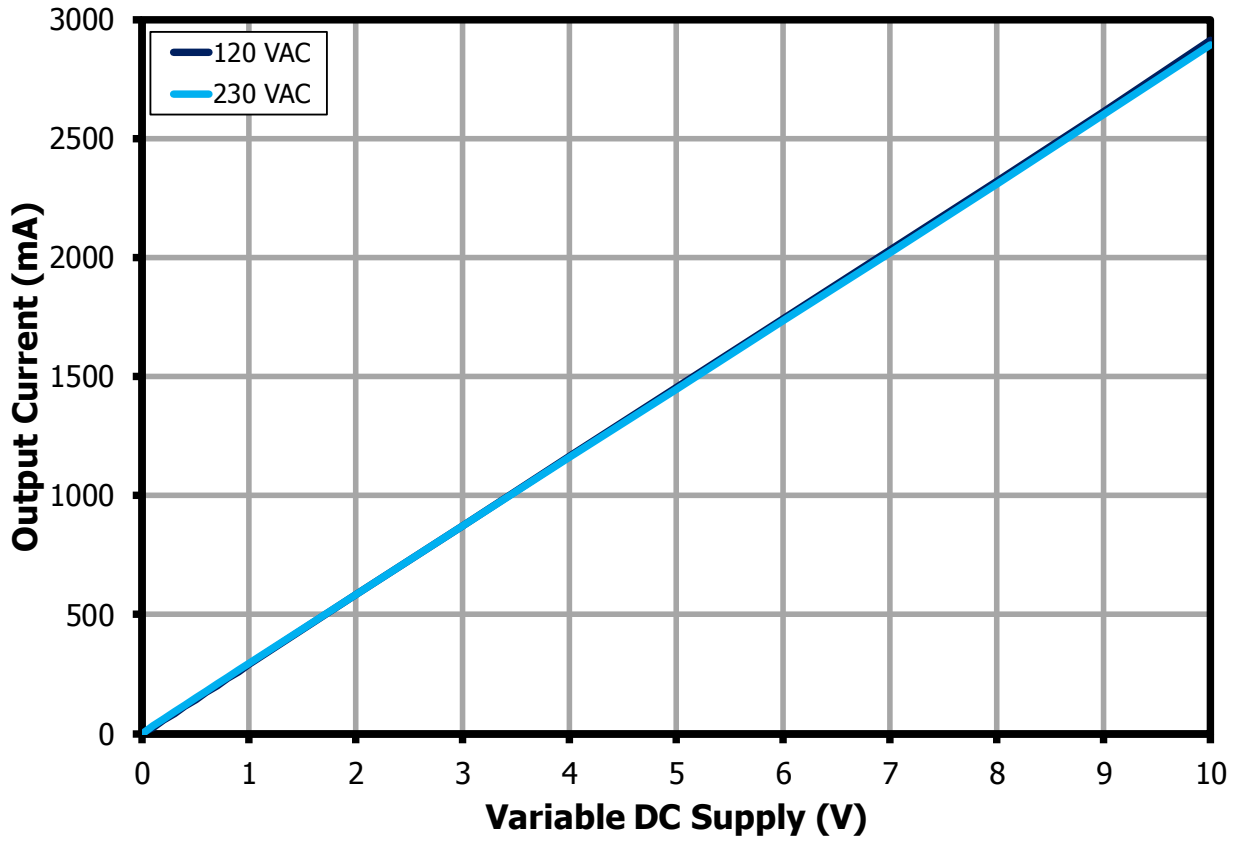
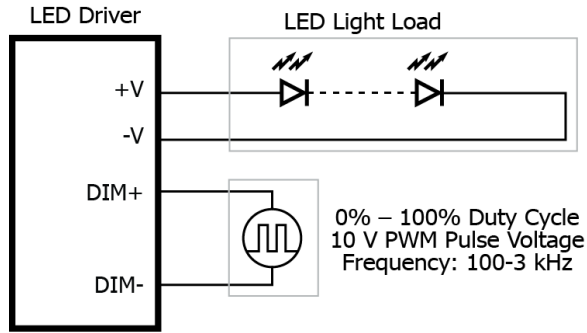

Figure 28 – 0 V – 10 V Dimming Curve at 33 V LED Load.

13.1.2 10 V 3 kHz to 300 Hz PWM Dimming Curve



PI-8490-101117

Figure 29 – 10 V, 1 KHz PWM Dimming Set-up.

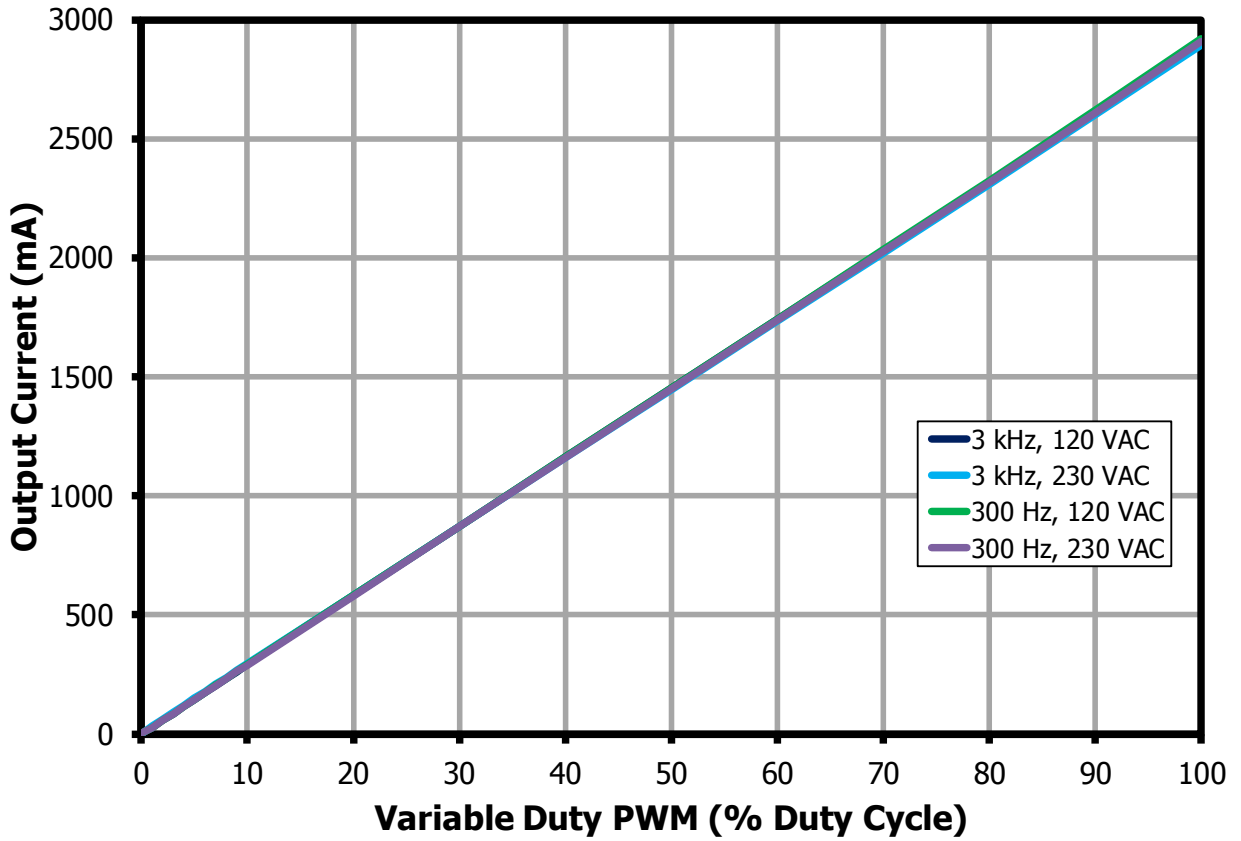

Figure 30 – 1 kHz, 10 V PWM Dimming Curve at 42 V LED Load.



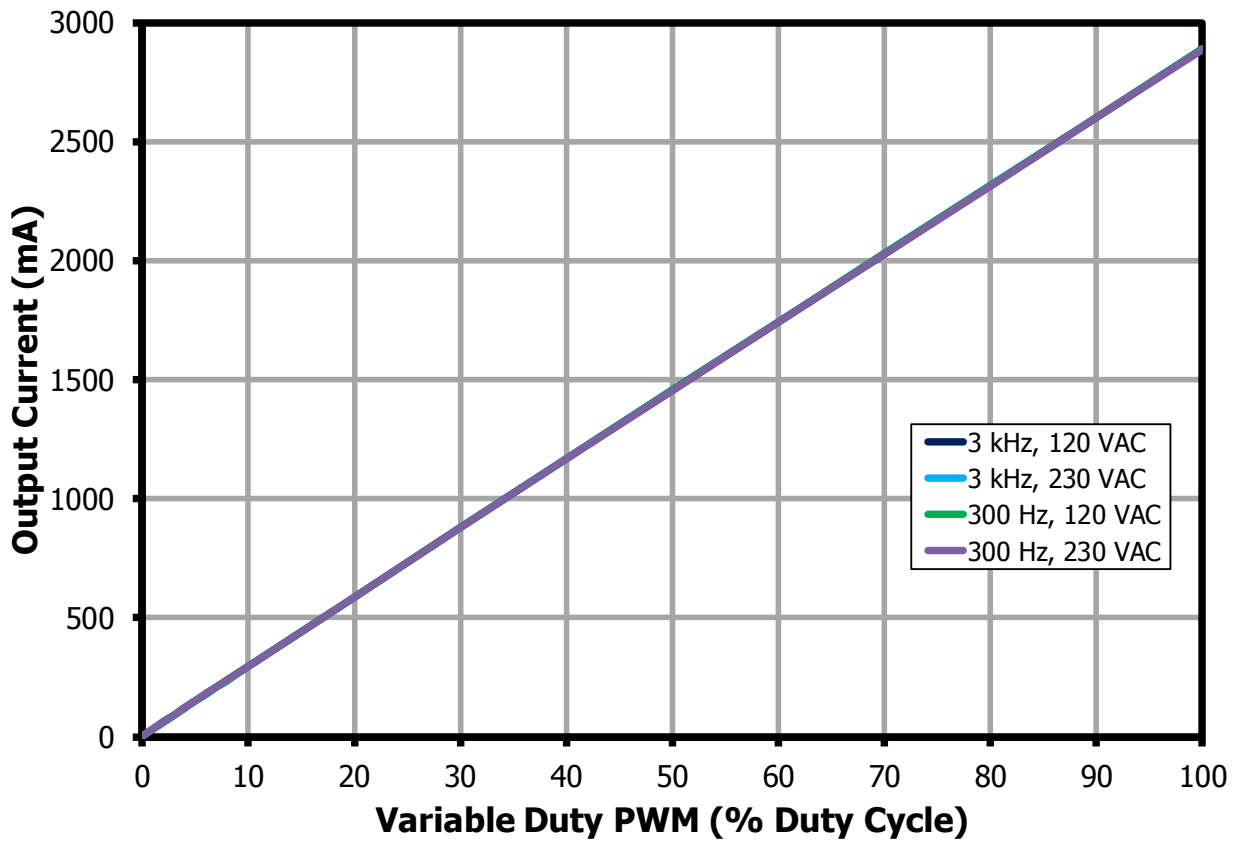
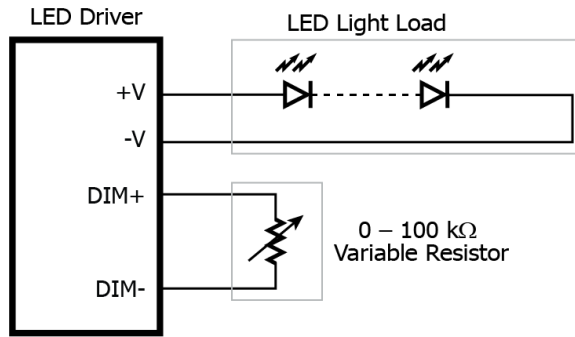

Figure 31 – 1 kHz, 10 V PWM Dimming Curve at 33 V LED Load.

13.1.3 Variable Resistor Dimming Curve



PI-8491-101117

Figure 32 – 0 Ω - 100 kΩ Variable Resistor Dimming Set-up.

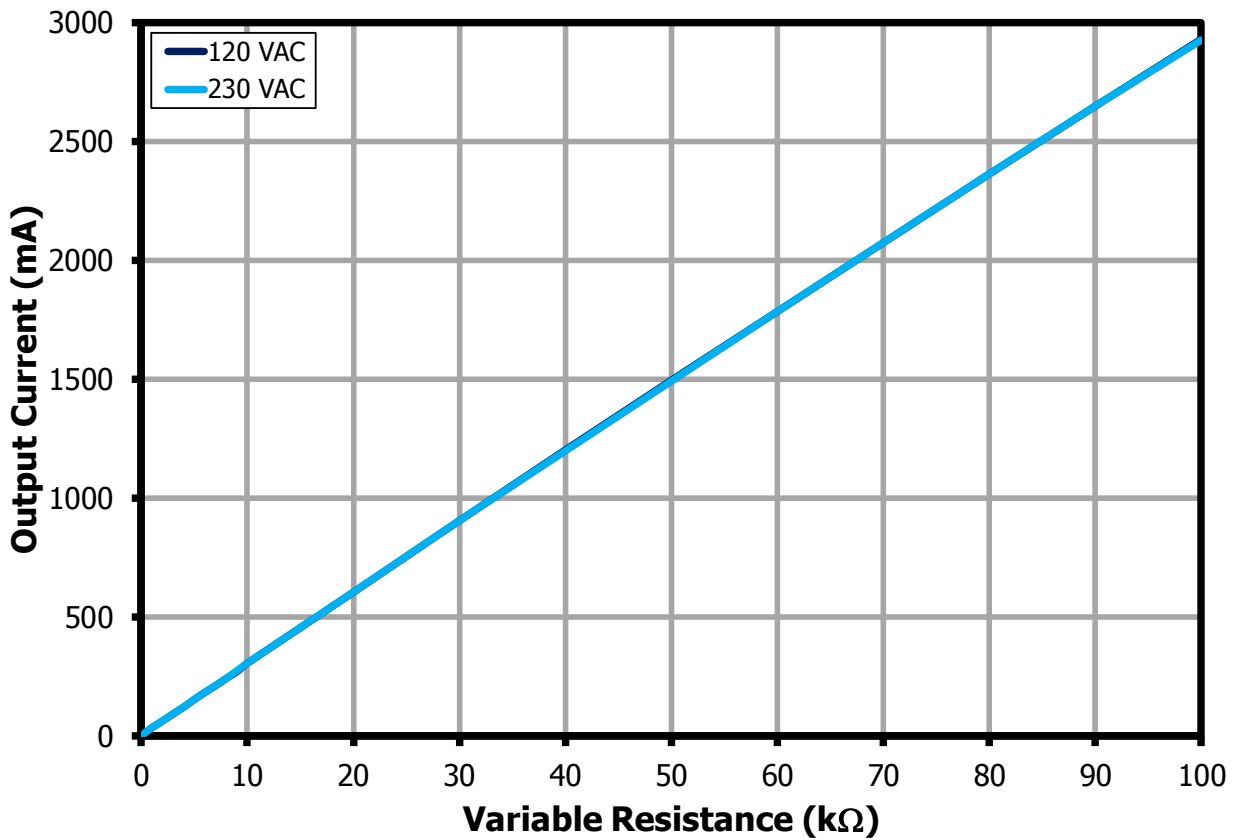

Figure 33 – 0 Ω - 100 kΩ Variable Resistor Dimming Curve at 42 V LED Load.



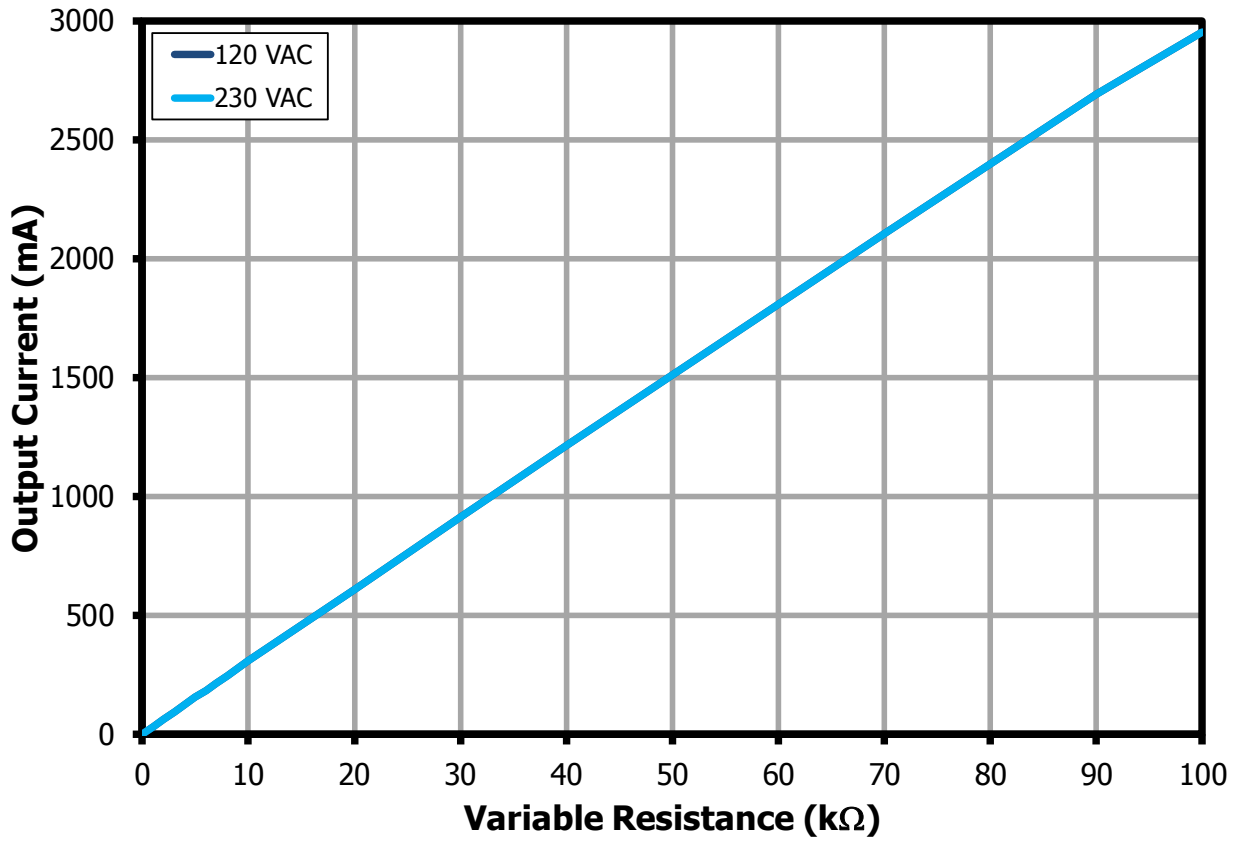

Figure 34 – 0 Ω - 100 kΩ Variable Resistor Dimming Curve at 33 V LED Load.

14 Thermal Performance

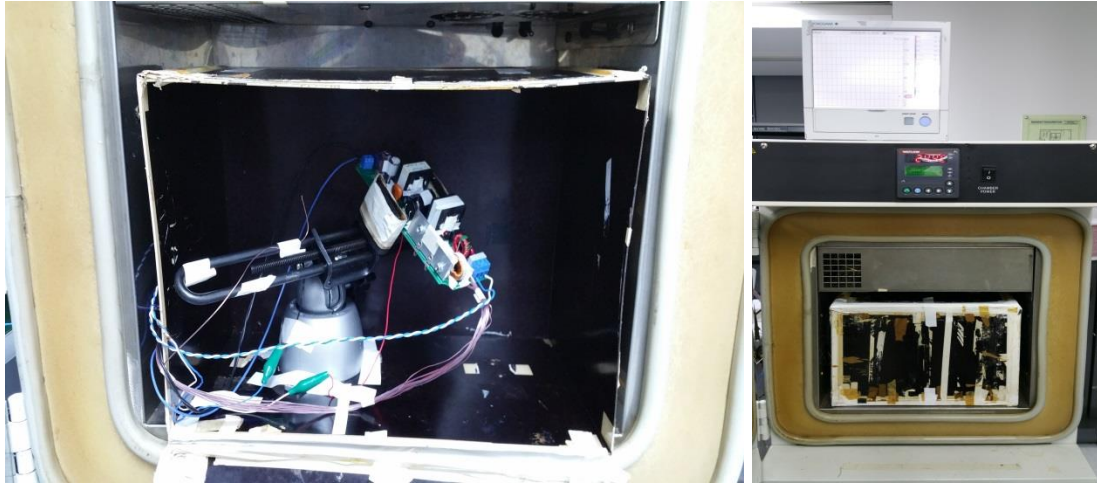

Figure 35 – Test Set-up Picture - Open Frame.

14.1 *Thermal Scan at 25 °C Ambient*

Unit in open frame was placed inside an enclosure to prevent airflow that might affect the thermal measurements. Ambient temperature inside enclosure is ~25 °C. Temperature was measured using type T thermocouple.

14.1.1 Thermal Scan at 100 VAC Full Load

Thermal scan was performed at worst case input voltage of 100 VAC at room ambient temperature with enclosure.

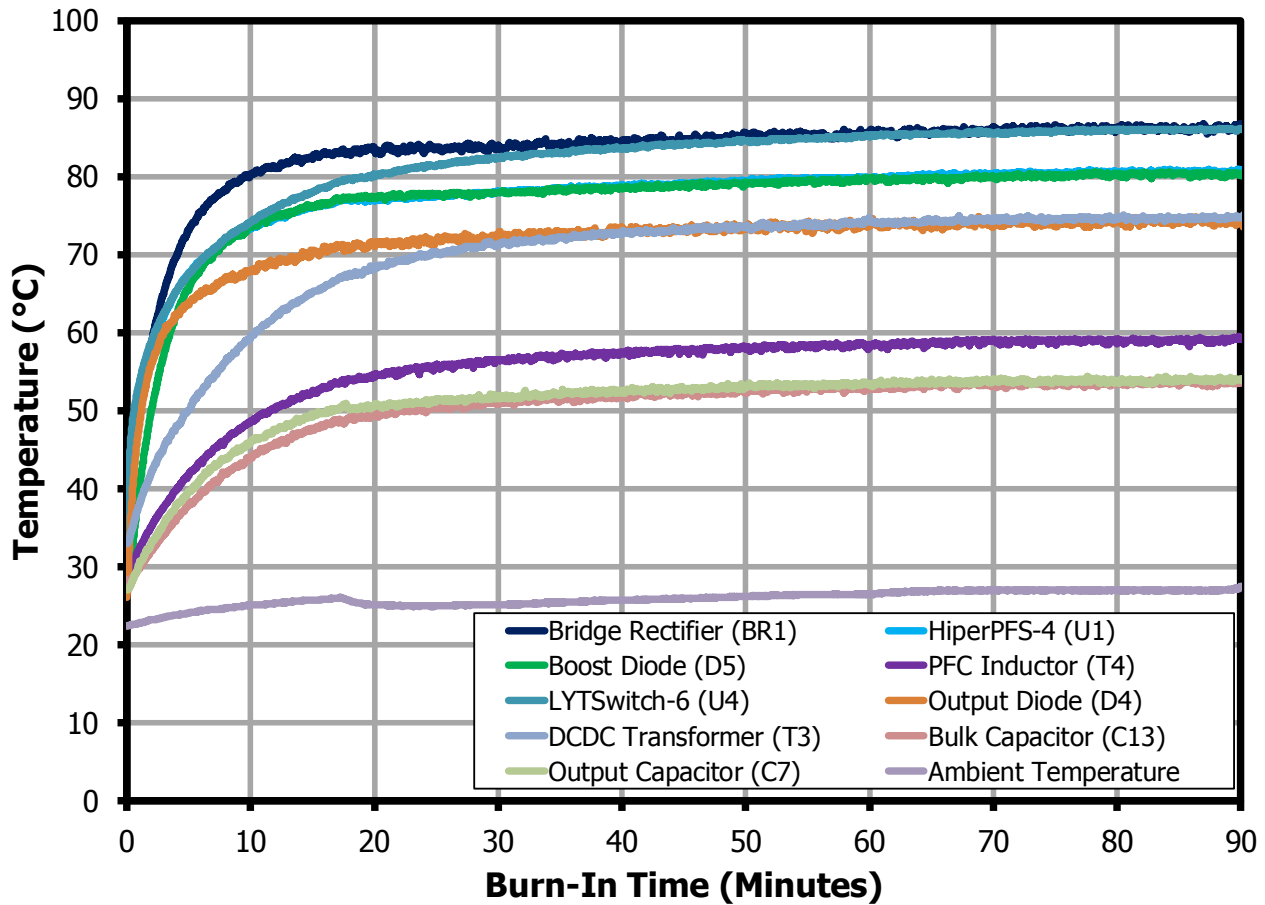

Figure 36 – Thermal Scan, 100 VAC Full Load – 25 °C Ambient Temperature.

No.	Ckt. Code	Description	Thermal Reading (°C), 25 °C Ambient
			Open-Frame
			100 VAC 60 Hz
1	BR1	Bridge Diode	86.8
2	U2	HiperPFS-4	80.7
3	D5	PFC Output Diode	80.3
4	T4	PFC Inductor Winding	60
5	U4	LYTSwitch-6	86.2
6	D4	Output Diode	74.4
7	T3	DCDC Main Transformer Winding	74.9
8	C13	PFC Bulk Capacitor	53.7
9	C7	Output Capacitor	54
10	Amb	Ambient Temp	27.4

14.2 **Thermal Performance at 50 °C Ambient**

Unit in open frame was placed inside an enclosure to prevent airflow that might affect the thermal measurements. Ambient temperature inside enclosure is 50 °C and was kept constant for 90 mins before taking measurements. Temperature was measured using type T thermocouple.

No.	Ckt. Code	Description	Thermal Reading (°C), 50 °C Ambient
			Open-Frame
			100 VAC 60 Hz
1	BR1	Bridge Diode	104.1
2	U2	HiperPFS-4	105.3
3	D5	PFC Output Diode	100
4	T4	PFC Inductor Winding	74.9
5	U4	LYTSwitch-6	118.7
6	D4	Output Diode	95.9
7	T3	DCDC Main Transformer Winding	101.6
8	C13	PFC Bulk Capacitor	76.1
9	C7	Output Capacitor	79.4
10	Amb	Ambient Temp	49

15 Waveforms

15.1 Input Voltage and Input Current at 42 V LED Load

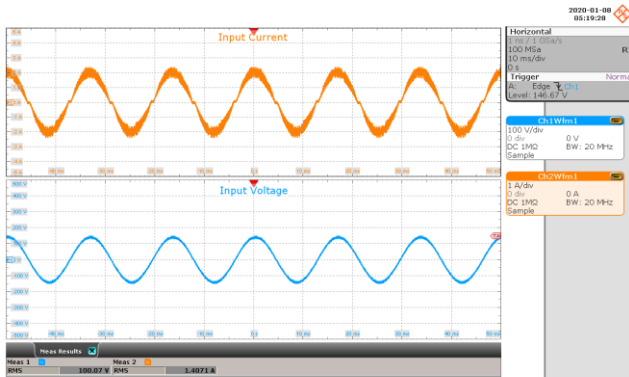

Figure 37 – 100 VAC, 42 V LED Load.
Upper: I_{IN} , 1 A / div.
Lower: V_{IN} , 100 V / div., 10 ms / div.

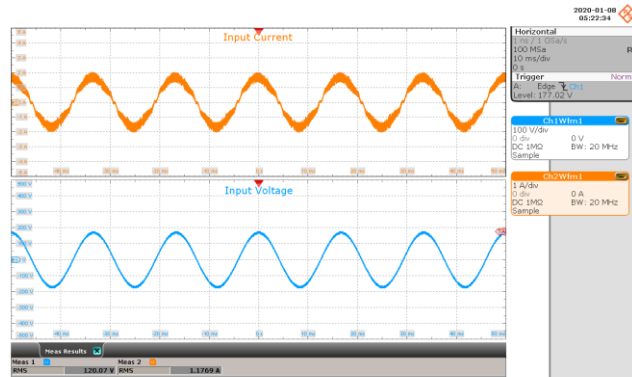

Figure 38 – 120 VAC, 42 V LED Load.
Upper: I_{IN} , 1 A / div.
Lower: V_{IN} , 100 V / div., 10 ms / div.

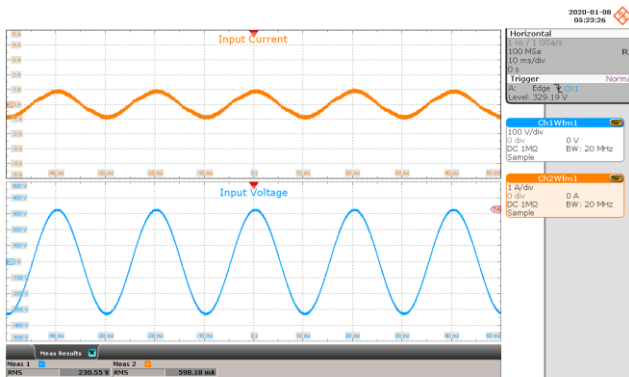

Figure 39 – 230 VAC, 42 V LED Load.
Upper: I_{IN} , 1 A / div.
Lower: V_{IN} , 100 V / div., 10 ms / div.

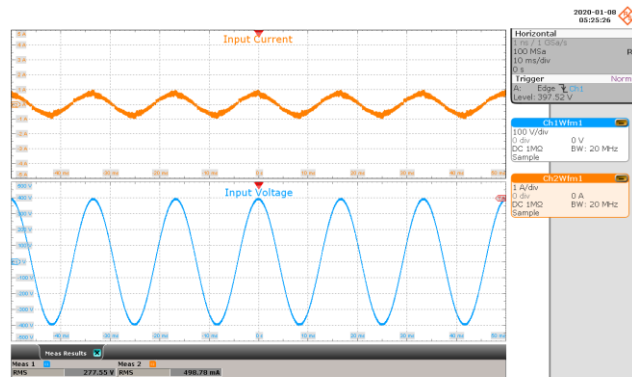

Figure 40 – 277 VAC, 42 V LED Load.
Upper: I_{IN} , 1 A / div.
Lower: V_{IN} , 100 V / div., 10 ms / div.

15.2 **Start-up Profile at 42 V LED Load**

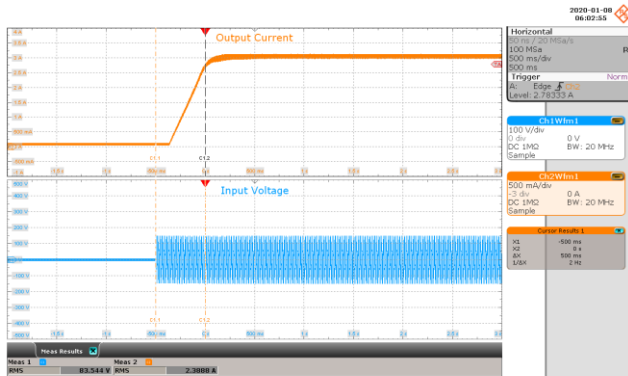

Figure 41 – 100 VAC, 42 V LED, Output Rise.
 Upper: I_{OUT} , 500 mA / div.
 Lower: V_{IN} , 100 V / div., 500 ms / div.

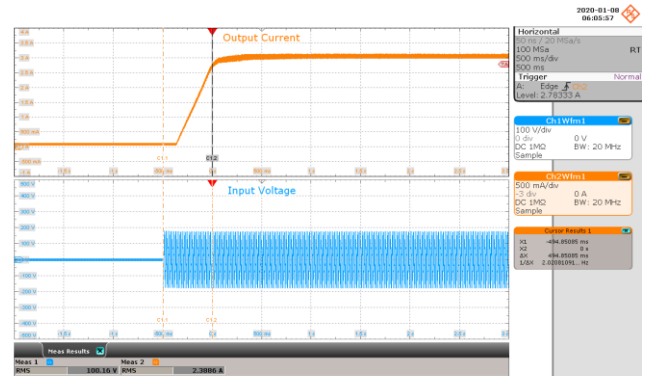

Figure 42 – 120 VAC, 42 V LED, Output Rise.
 Upper: I_{OUT} , 500 mA / div.
 Lower: V_{IN} , 100 V / div., 500 ms / div.

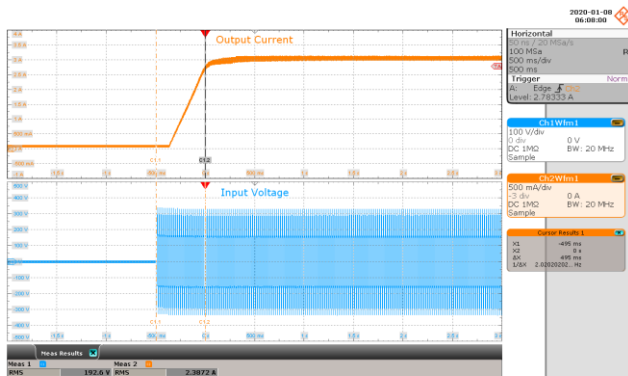

Figure 43 – 230 VAC, 42 V LED, Output Rise.
 Upper: I_{OUT} , 500 mA / div.
 Lower: V_{IN} , 100 V / div., 500 ms / div.

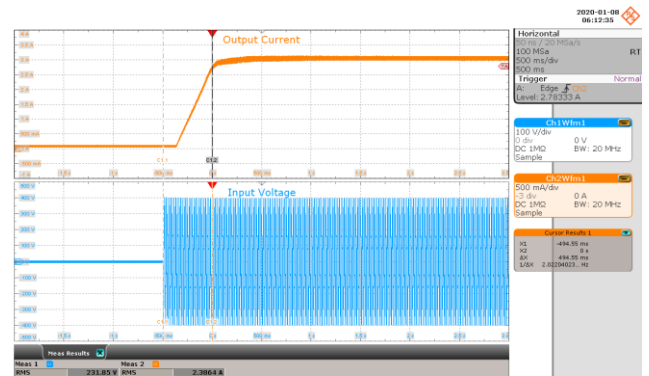

Figure 44 – 277 VAC, 42 V LED, Output Rise.
 Upper: I_{OUT} , 500 mA / div.
 Lower: V_{IN} , 100 V / div., 500 ms / div.



15.3 **Start-up Profile at 33 V LED Load**

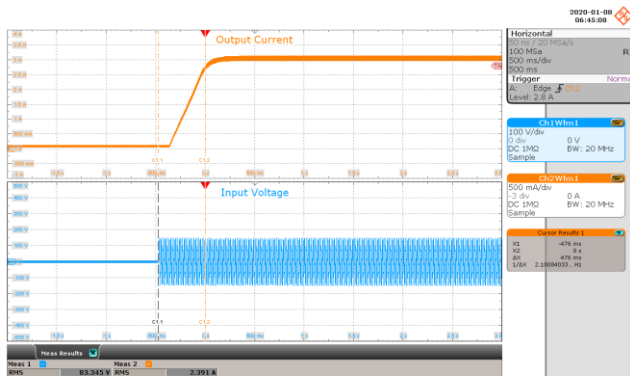

Figure 45 – 100 VAC, 33 V LED, Output Rise.
 Upper: I_{OUT} , 500 mA / div.
 Lower: V_{IN} , 100 V / div., 500 ms / div.

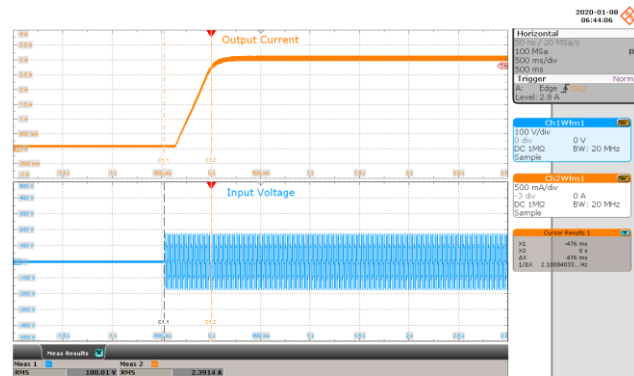

Figure 46 – 120 VAC, 33 V LED, Output Rise.
 Upper: I_{OUT} , 500 mA / div.
 Lower: V_{IN} , 100 V / div., 500 ms / div.

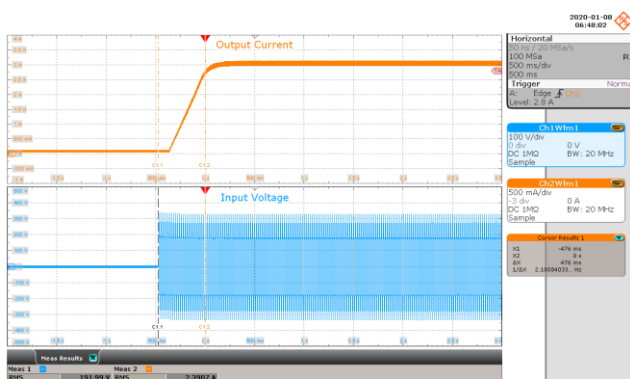

Figure 47 – 230 VAC, 33 V LED, Output Rise.
 Upper: I_{OUT} , 500 mA / div.
 Lower: V_{IN} , 100 V / div., 500 ms / div.

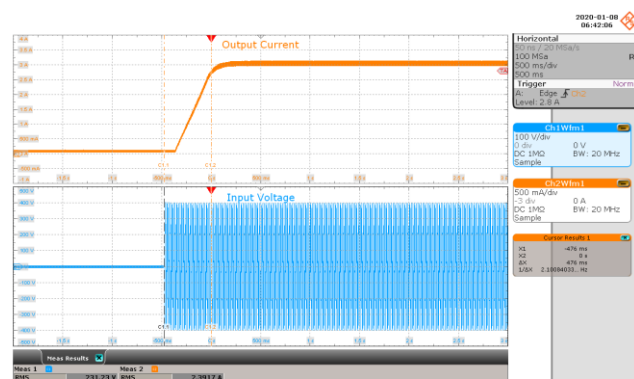

Figure 48 – 277 VAC, 33 V LED, Output Rise.
 Upper: I_{OUT} , 500 mA / div.
 Lower: V_{IN} , 100 V / div., 500 ms / div.

15.4 **Output Current Fall at 42 V LED Load**

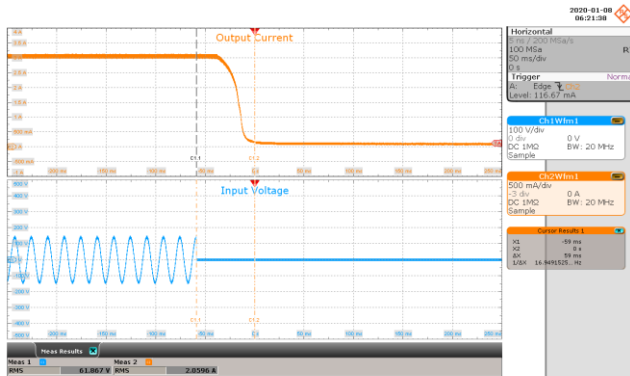

Figure 49 – 100 VAC, 42 V LED, Output Fall.
Upper: I_{OUT} , 500 mA / div.
Lower: V_{IN} , 100 V / div., 50 ms / div.

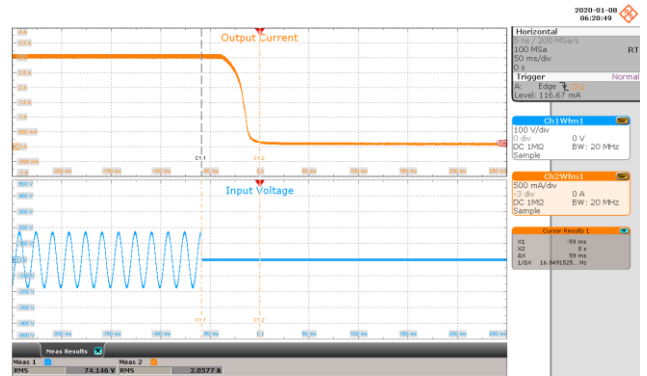

Figure 50 – 120 VAC, 42 V LED, Output Fall.
Upper: I_{OUT} , 500 mA / div.
Lower: V_{IN} , 100 V / div., 50 ms / div.

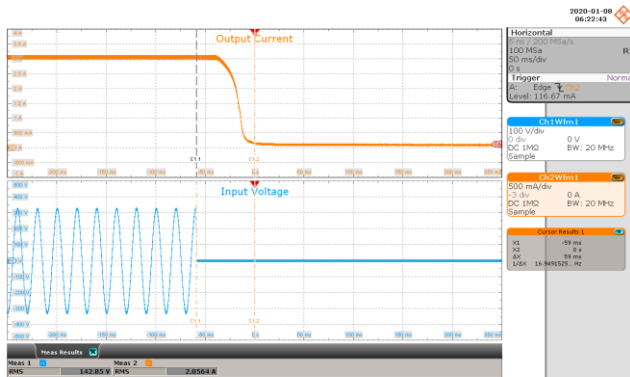

Figure 51 – 230 VAC, 42 V LED, Output Fall.
Upper: I_{OUT} , 500 mA / div.
Lower: V_{IN} , 100 V / div., 50 ms / div.

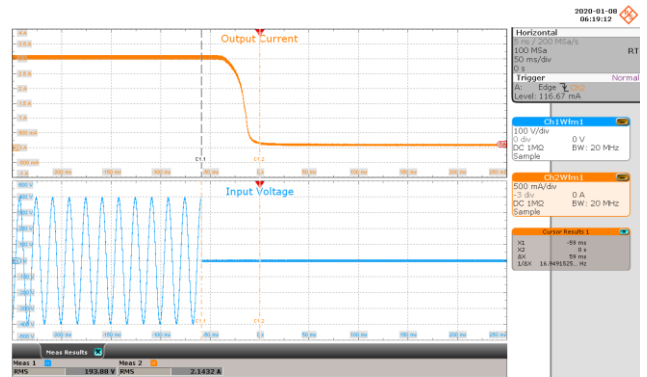

Figure 52 – 277 VAC, 42 V LED, Output Fall.
Upper: I_{OUT} , 500 mA / div.
Lower: V_{IN} , 100 V / div., 50 ms / div.

15.5 **Output Current Fall at 33 V LED Load**

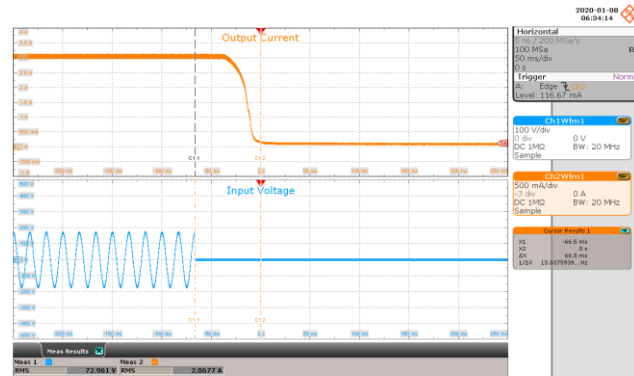
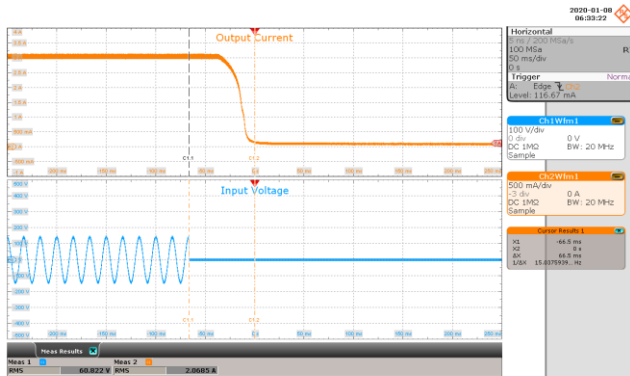

Figure 53 – 100 VAC, 33 V LED, Output Fall.
Upper: I_{OUT} , 500 mA / div.
Lower: V_{IN} , 100 V / div., 50 ms / div.

Figure 54 – 120 VAC, 33 V LED, Output Fall.
Upper: I_{OUT} , 500 mA / div.
Lower: V_{IN} , 100 V / div., 50 ms / div.

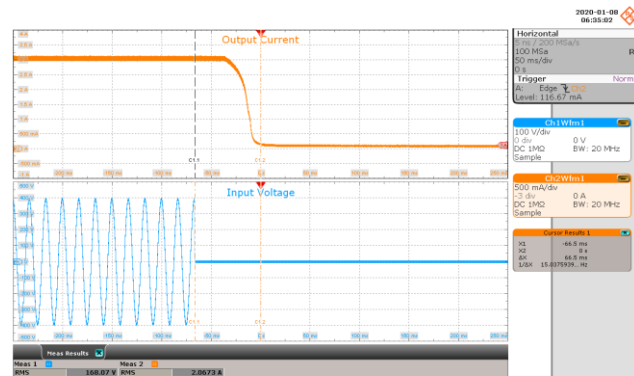
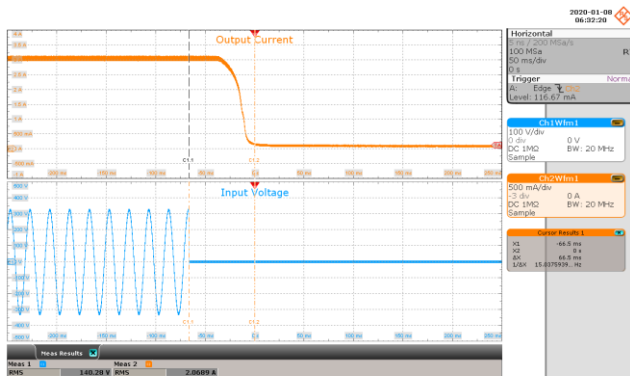

Figure 55 – 230 VAC, 33 V LED, Output Fall.
Upper: I_{OUT} , 500 mA / div.
Lower: V_{IN} , 100 V / div., 50 ms / div.

Figure 56 – 277 VAC, 33 V LED, Output Fall.
Upper: I_{OUT} , 500 mA / div.
Lower: V_{IN} , 100 V / div., 50 ms / div.

15.6 **PFS7628C (U2) Drain Voltage and Current at Normal Operation**

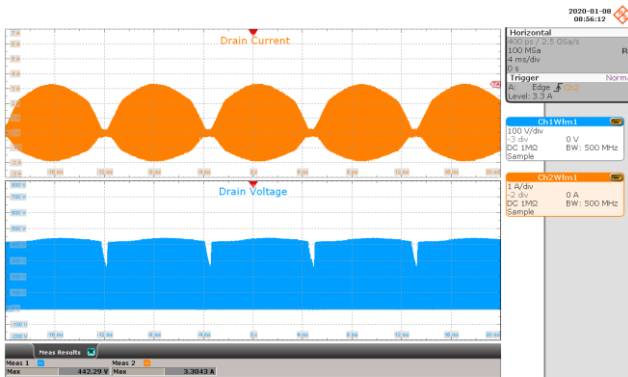

Figure 57 – 100 VAC, 42 V LED Load.
 Upper: I_{DRAIN} , 1 A / div.
 Lower: V_{DRAIN} , 100 V / div., 4 ms / div.

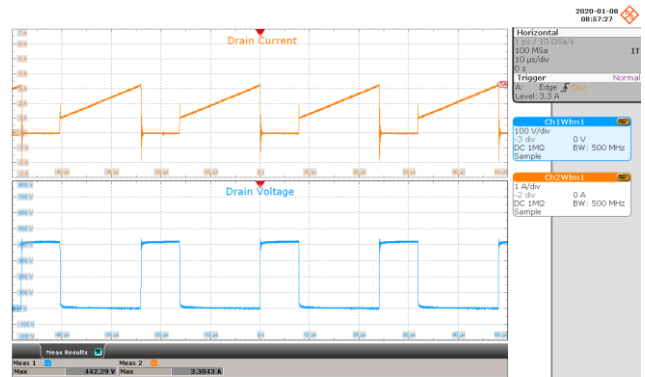

Figure 58 – 100 VAC, 42 V LED Load.
 Upper: I_{DRAIN} , 1 A / div.
 Lower: V_{DRAIN} , 100 V / div., 10 µs / div.

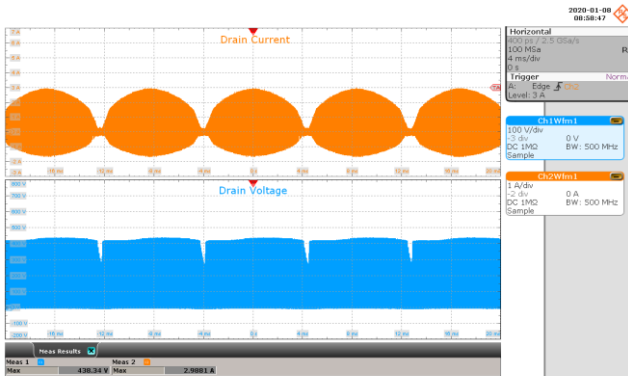

Figure 59 – 120 VAC, 42 V LED Load.
 Upper: I_{DRAIN} , 1 A / div.
 Lower: V_{DRAIN} , 100 V / div., 4 ms / div.

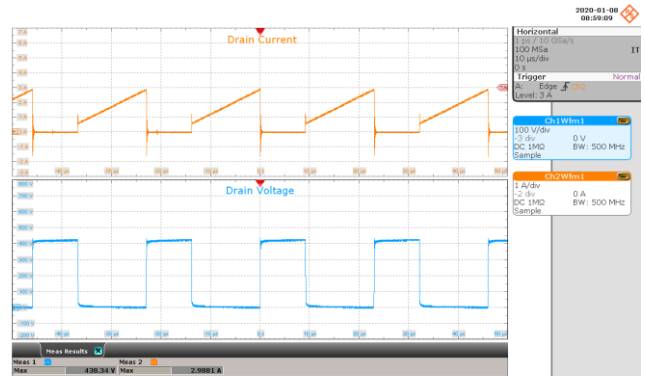

Figure 60 – 120 VAC, 42 V LED Load.
 Upper: I_{DRAIN} , 1 A / div.
 Lower: V_{DRAIN} , 100 V / div., 10 µs / div.

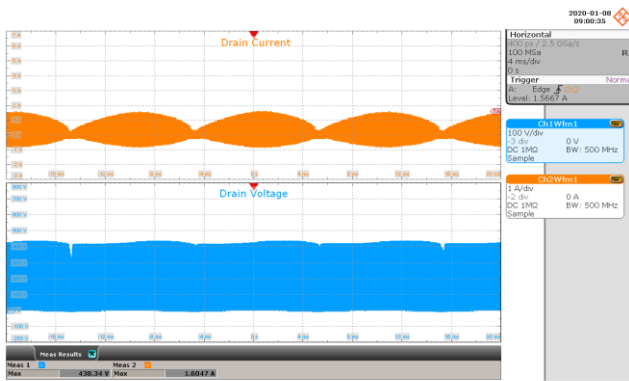

Figure 61 – 230 VAC, 42 V LED Load.
 Upper: I_{DRAIN} , 1 A / div.
 Lower: V_{DRAIN} , 100 V / div., 4 ms / div.

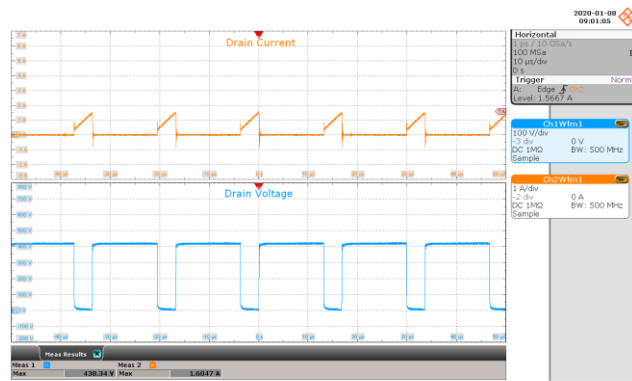

Figure 62 – 230 VAC, 42 V LED Load.
 Upper: I_{DRAIN} , 1 A / div.
 Lower: V_{DRAIN} , 100 V / div., 10 μ s / div.

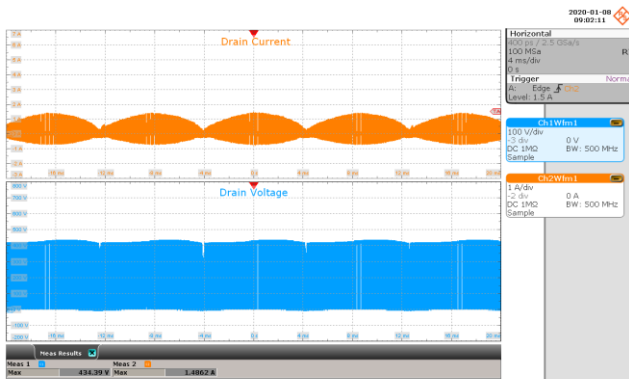

Figure 63 – 277 VAC, 42 V LED Load.
 Upper: I_{DRAIN} , 1 A / div.
 Lower: V_{DRAIN} , 100 V / div., 4 ms / div.

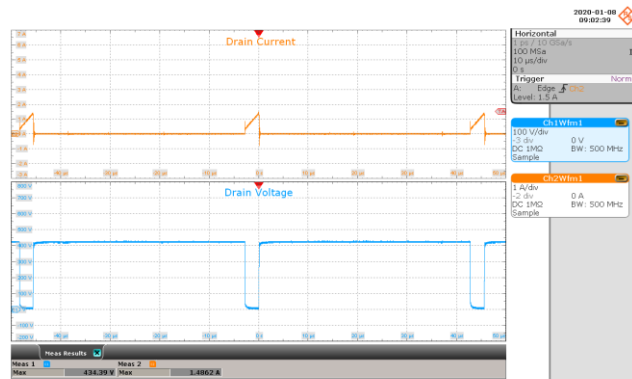

Figure 64 – 277 VAC, 42 V LED Load.
 Upper: I_{DRAIN} , 1 A / div.
 Lower: V_{DRAIN} , 100 V / div., 10 μ s / div.

15.7 **PFS7626C (U2) Drain Voltage and Current at Start-up**

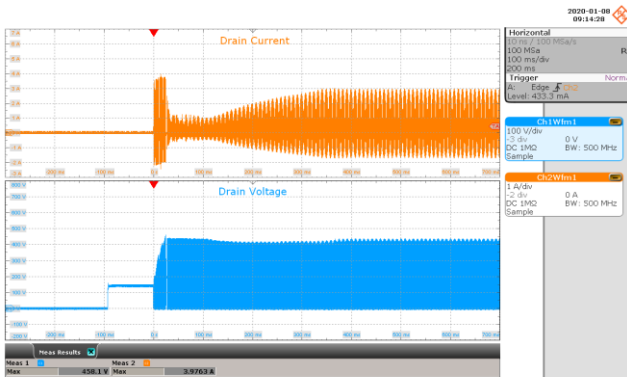

Figure 65 – 100 VAC, 42 V LED Load.
 Upper: I_{DRAIN} , 1 A / div.
 Lower: V_{DRAIN} , 100 V / div., 100 ms / div.

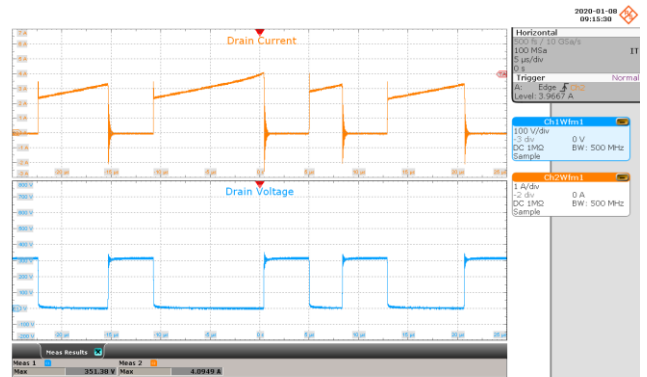

Figure 66 – 100 VAC, 42 V LED Load.
 Upper: I_{DRAIN} , 1 A / div.
 Lower: V_{DRAIN} , 100 V / div., 5 μ s / div.

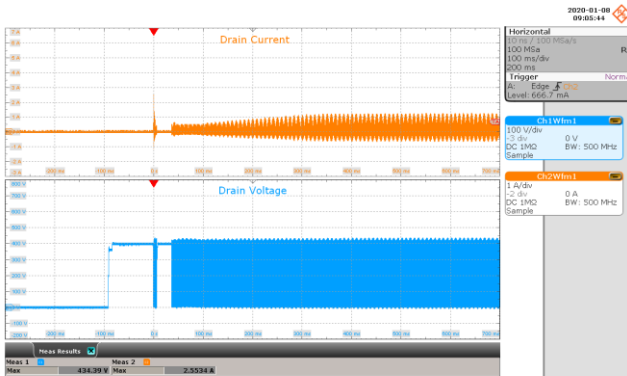

Figure 67 – 277 VAC, 42 V LED Load.
 Upper: I_{DRAIN} , 1 A / div.
 Lower: V_{DRAIN} , 100 V / div., 100 ms / div.

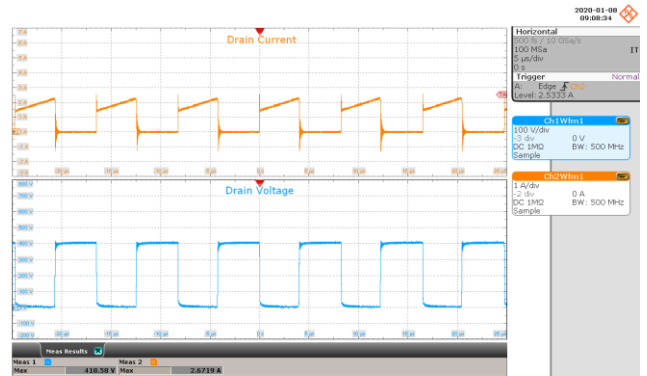

Figure 68 – 277 VAC, 42 V LED Load.
 Upper: I_{DRAIN} , 1 A / div.
 Lower: V_{DRAIN} , 100 V / div., 5 μ s / div.



15.8 **LYTSwitch-6 (U4) Drain Voltage and Current at Normal Operation**

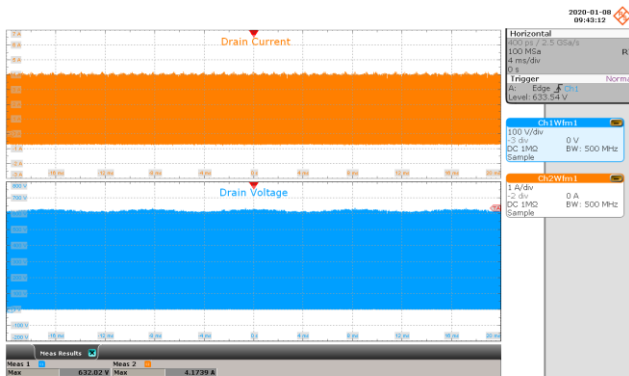

Figure 69 – 100 VAC, 42 V LED Load.
 Upper: I_{DRAIN} , 1 A / div.
 Lower: V_{DRAIN} , 100 V / div., 4 ms / div.



Figure 70 – 100 VAC, 42 V LED Load.
 Upper: I_{DRAIN} , 1 A / div.
 Lower: V_{DRAIN} , 100 V / div., 10 μ s / div.



Figure 71 – 120 VAC, 42 V LED Load.
 Upper: I_{DRAIN} , 1 A / div.
 Lower: V_{DRAIN} , 100 V / div., 4 ms / div.



Figure 72 – 120 VAC, 42 V LED Load.
 Upper: I_{DRAIN} , 1 A / div.
 Lower: V_{DRAIN} , 100 V / div., 10 μ s / div.

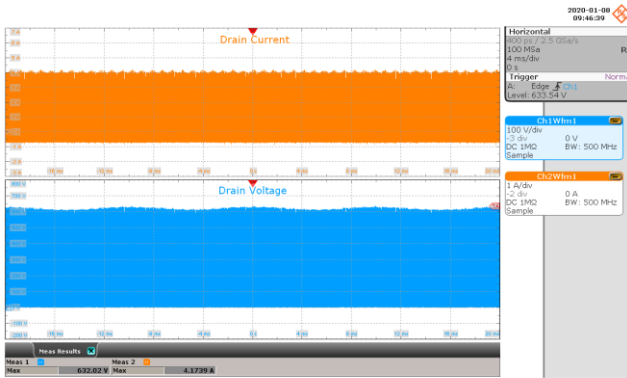

Figure 73 – 230 VAC, 42 V LED Load.
Upper: I_{DRAIN} , 1 A / div.
Lower: V_{DRAIN} , 100 V / div., 4 ms / div.



Figure 74 – 230 VAC, 42 V LED Load.
Upper: I_{DRAIN} , 1 A / div.
Lower: V_{DRAIN} , 100 V / div., 10 μ s / div.

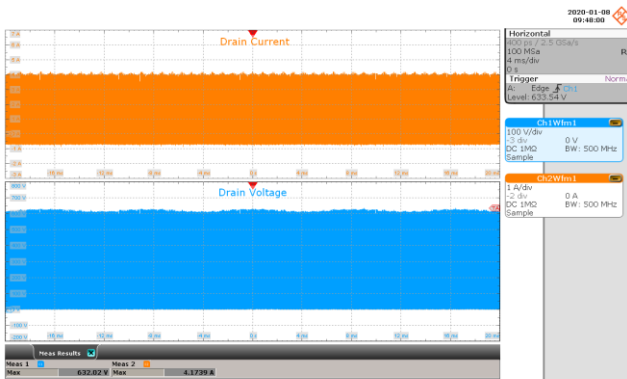

Figure 75 – 277 VAC, 42 V LED Load.
Upper: I_{DRAIN} , 1 A / div.
Lower: V_{DRAIN} , 100 V / div., 4 ms / div.



Figure 76 – 277 VAC, 42 V LED Load.
Upper: I_{DRAIN} , 1 A / div.
Lower: V_{DRAIN} , 100 V / div., 10 μ s / div.

15.9 **LYTSwitch-6 (U4) Drain Voltage and Current at Start-up**

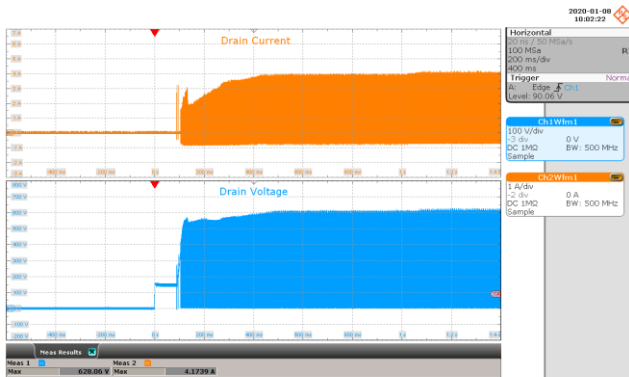

Figure 77 – 100 VAC, 42 V LED Load.
 Upper: I_{DRAIN} , 1 A / div.
 Lower: V_{DRAIN} , 100 V / div., 200 ms / div.



Figure 78 – 100 VAC, 42 V LED Load.
 Upper: I_{DRAIN} , 1 A / div.
 Lower: V_{DRAIN} , 100 V / div., 20 µs / div.

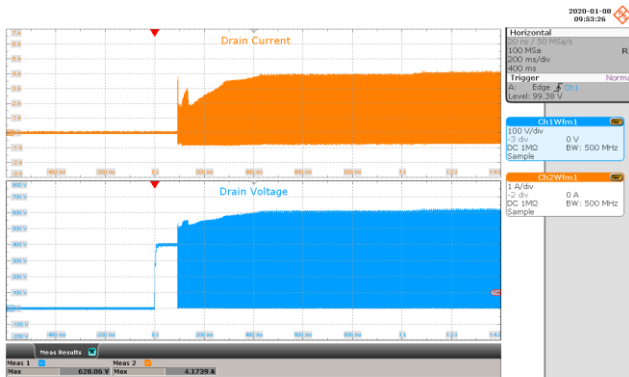

Figure 79 – 277 VAC, 42 V LED Load.
 Upper: I_{DRAIN} , 1 A / div.
 Lower: V_{DRAIN} , 100 V / div., 200 ms / div.



Figure 80 – 277 VAC, 42 V LED Load.
 Upper: I_{DRAIN} , 1 A / div.
 Lower: V_{DRAIN} , 100 V / div., 20 µs / div.

15.10 **LYTSwitch-6 (U4) Drain Voltage and Current during Output Short-Circuit**

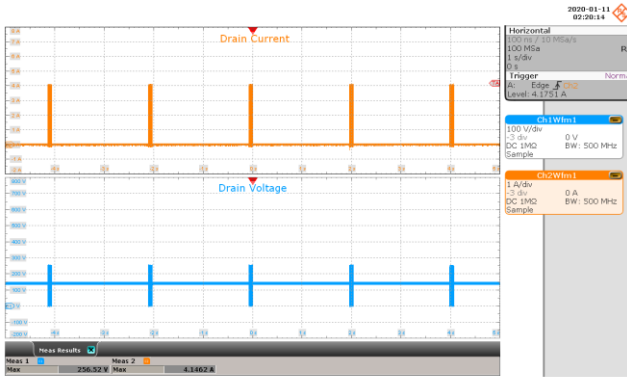

Figure 81 – 100 VAC, Output Shorted.
 Upper: I_{DRAIN} , 1 A / div.
 Lower: V_{DRAIN} , 100 V / div., 1 s / div.

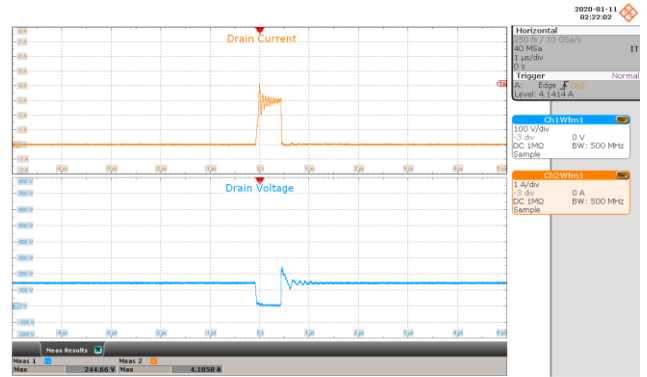

Figure 82 – 100 VAC, Output Shorted.
 Upper: I_{DRAIN} , 1 A / div.
 Lower: V_{DRAIN} , 100 V / div., 1 μ s / div.



Figure 83 – 277 VAC, Output Shorted.
 Upper: I_{DRAIN} , 1 A / div.
 Lower: V_{DRAIN} , 100 V / div., 1 s / div.

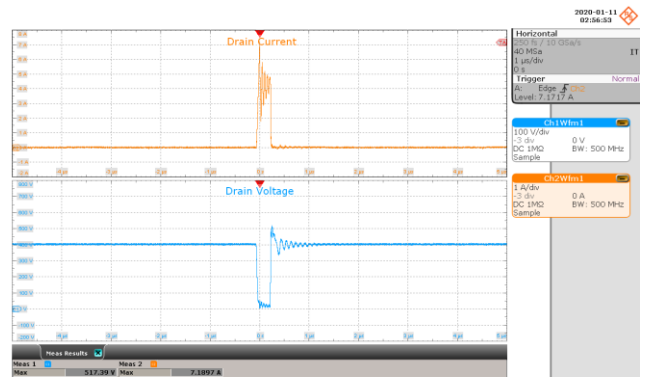

Figure 84 – 277 VAC, Output Shorted.
 Upper: I_{DRAIN} , 1 A / div.
 Lower: V_{DRAIN} , 100 V / div., 1 μ s / div.

15.11 **Output Ripple Current at Full load**

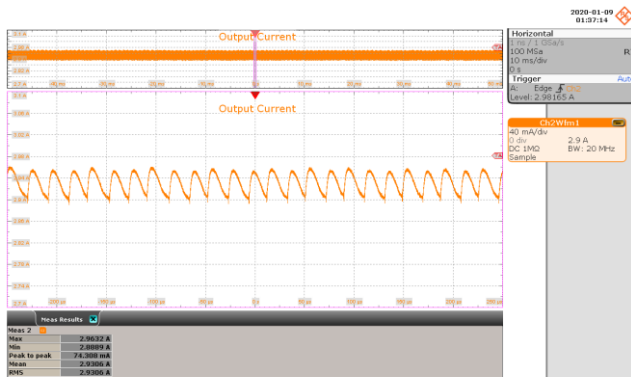

Figure 85 – 100 VAC, 60 Hz, 42 V LED Load.
Upper: I_{OUT} , 40 mA / div., 50 μ s / div.

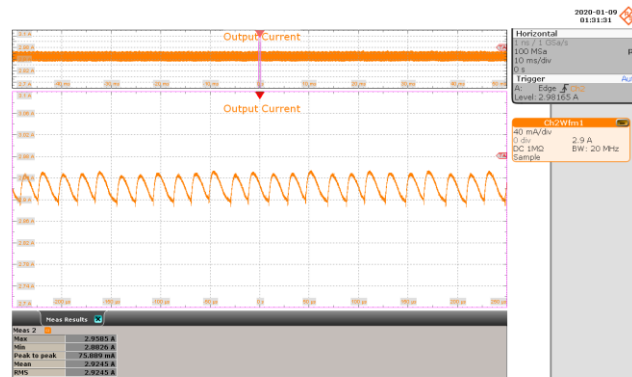

Figure 86 – 120 VAC, 60 Hz, 42 V LED Load.
Upper: I_{OUT} , 40 mA / div., 50 μ s / div.

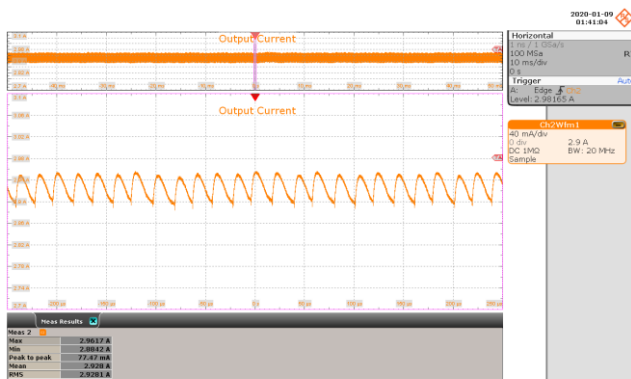

Figure 87 – 230 VAC, 50 Hz, 42 V LED Load.
Upper: I_{OUT} , 40 mA / div., 50 μ s / div.

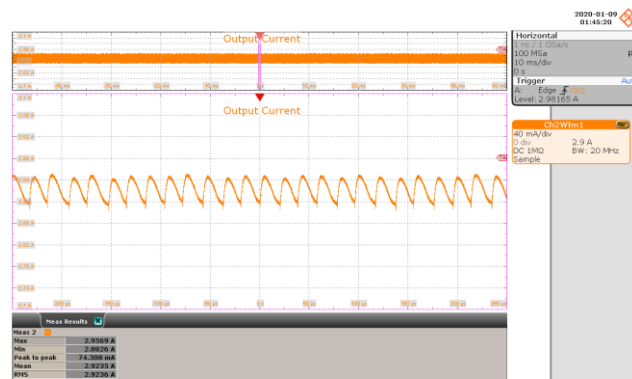

Figure 88 – 277 VAC, 60 Hz, 42 V LED Load.
Upper: I_{OUT} , 40 mA / div., 50 μ s / div.

V_{IN} (VAC)	I_{PK-PK} (mA)	I_{MEAN} (mA)	% Ripple		% Flicker	
			$100 \times (I_{RP-P}) / (I_{OUT})$	$100 \times (I_{RP-P}) / (2 \times I_{OUT})$		
100	74.31	3000	2.54	1.27		
120	75.09		2.60	1.30		
230	77.47		2.65	1.33		
277	74.31		2.54	1.27		

15.12 **Output Ripple Current at 33 V LED Load**

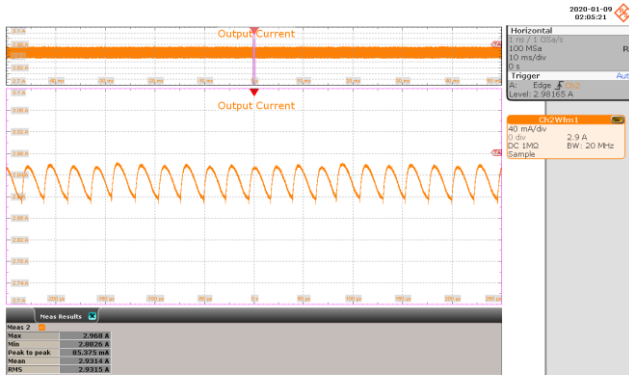

Figure 89 – 100 VAC, 60 Hz, 33 V LED Load.
Upper: I_{OUT} , 40 mA / div., 50 μ s / div.

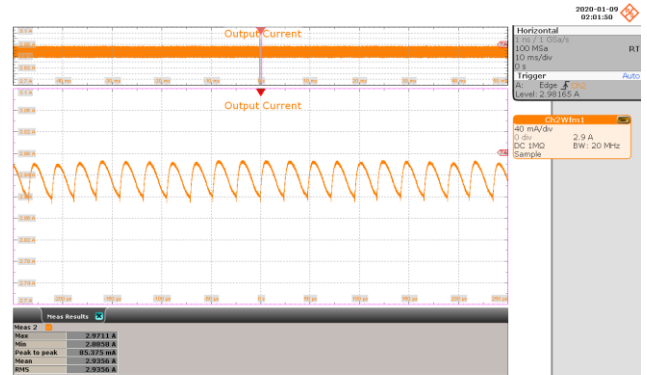

Figure 90 – 120 VAC, 20 Hz, 33 V LED Load.
Upper: I_{OUT} , 40 mA / div., 50 μ s / div.

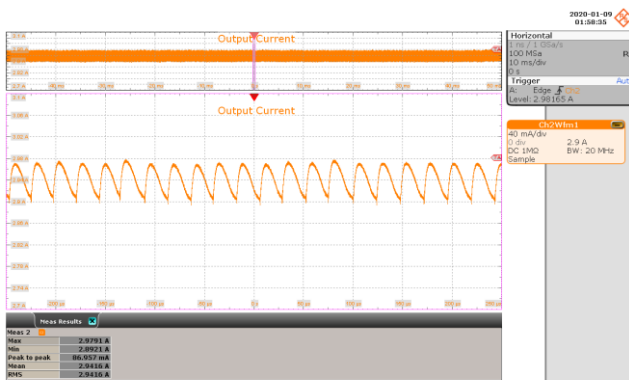

Figure 91 – 230 VAC, 50 Hz, 33 V LED Load.
Upper: I_{OUT} , 40 mA / div., 50 μ s / div.

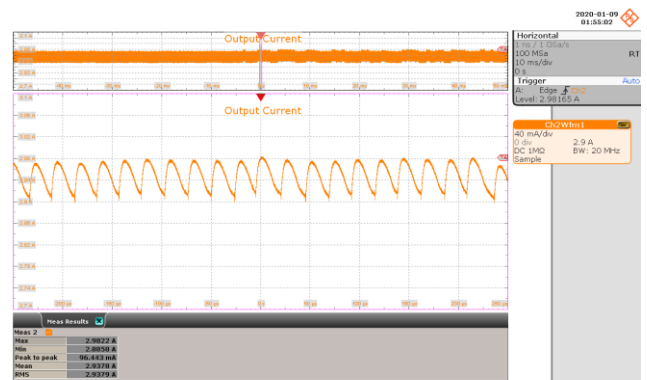

Figure 92 – 277 VAC, 60 Hz, 33 V LED Load.
Upper: I_{OUT} , 40 mA / div., 50 μ s / div.

V_{IN} (VAC)	I_{PK-PK} (mA)	I_{MEAN} (mA)	% Ripple	% Flicker
			$100 \times (I_{RP-P}) / (I_{OUT})$	$100 \times (I_{RP-P}) / (2 \times I_{OUT})$
100	85.38	3000	2.91	1.46
120	85.38		2.91	1.46
230	86.96		2.96	1.48
277	96.44		3.28	1.64



16 AC Cycling Test at 42 V LED Load

No output current overshoot or undershoot was observed during on/off cycling.

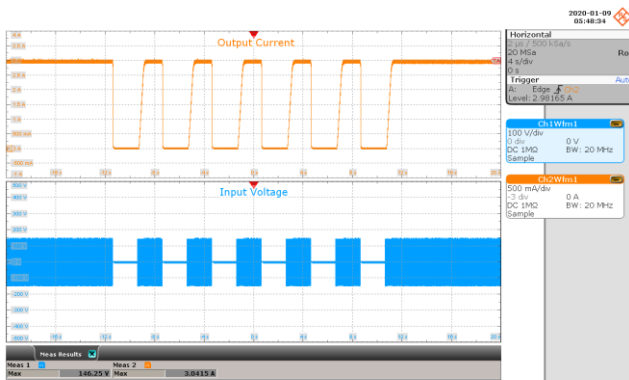

Figure 93 – 100 VAC, 42 V LED Load.
 2 s On – 2 s Off.
 Upper: I_{OUT} , 500 mA / div.
 Lower: V_{IN} , 100 V / div., 4 s / div.

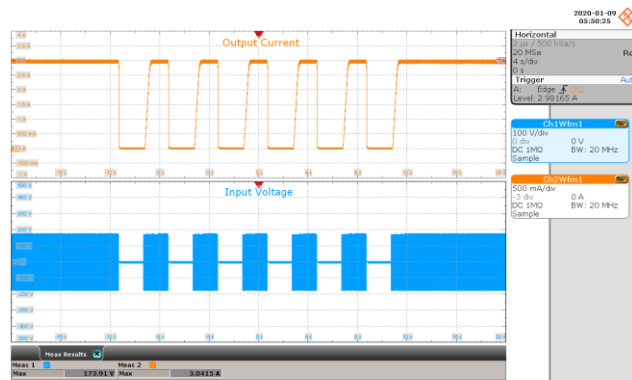

Figure 94 – 120 VAC, 42 V LED Load.
 2 s On – 2 s Off.
 Upper: I_{OUT} , 500 mA / div.
 Lower: V_{IN} , 100 V / div., 4 s / div.

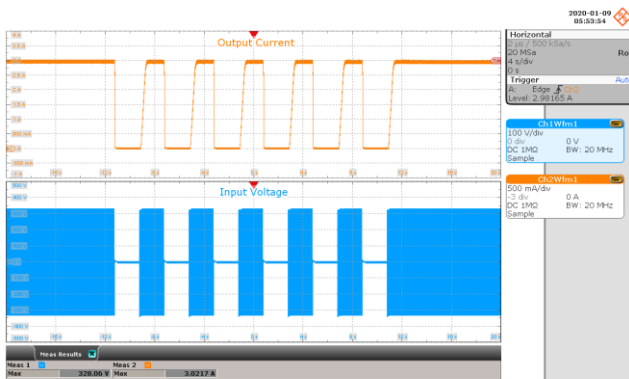

Figure 95 – 230 VAC, 42 V LED Load.
 2 s On – 2 s Off.
 Upper: I_{OUT} , 500 mA / div.
 Lower: V_{IN} , 100 V / div., 4 s / div.

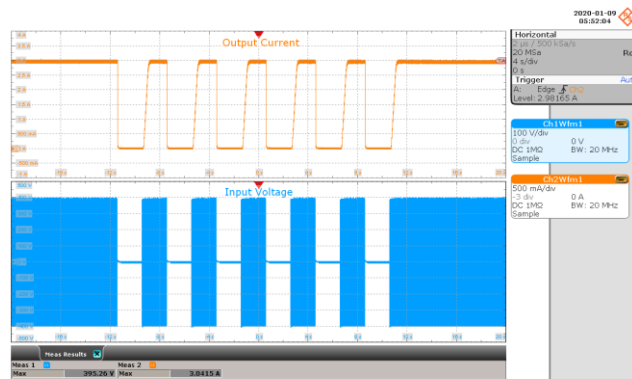

Figure 96 – 277 VAC, 42 V LED Load.
 2 s On – 2 s Off.
 Upper: I_{OUT} , 500 mA / div.
 Lower: V_{IN} , 100 V / div., 4 s / div.

17 AC Cycling Test at 33 V LED Load

No output current overshoot or undershoot was observed during on/off cycling.

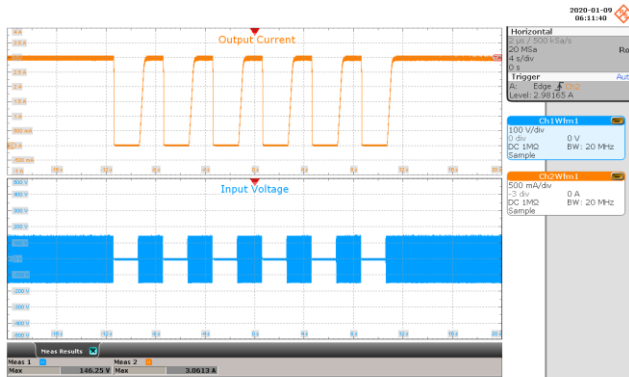

Figure 97 – 100 VAC, 33 V LED Load.
 2 s On – 2 s Off.
 Upper: I_{OUT} , 500 mA / div.
 Lower: V_{IN} , 100 V / div., 4 s / div.

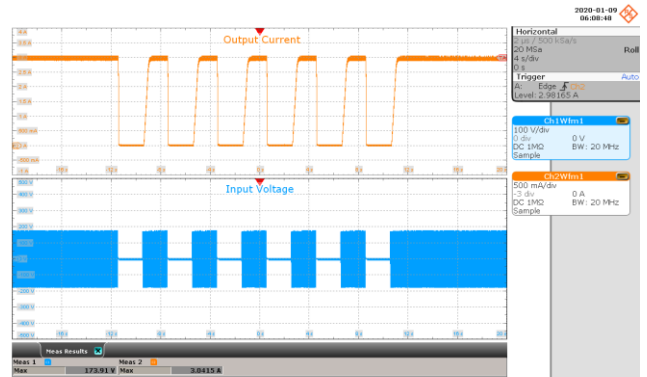

Figure 98 – 120 VAC, 33 V LED Load.
 2 s On – 2 s Off.
 Upper: I_{OUT} , 500 mA / div.
 Lower: V_{IN} , 100 V / div., 4 s / div.

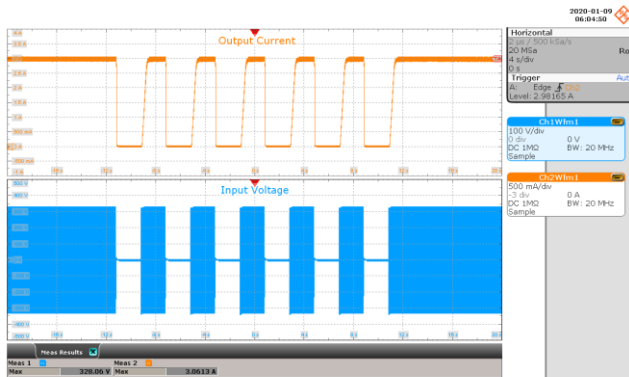

Figure 99 – 230 VAC, 33 V LED Load.
 2 s On – 2 s Off.
 Upper: I_{OUT} , 500 mA / div.
 Lower: V_{IN} , 100 V / div., 4 s / div.

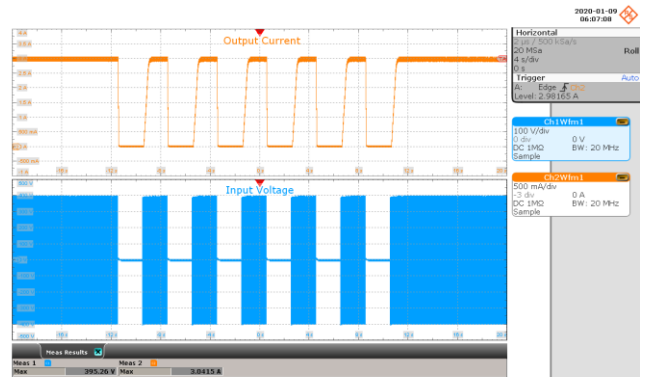

Figure 100 – 277 VAC, 33 V LED Load.
 2 s On – 2 s Off.
 Upper: I_{OUT} , 500 mA / div.
 Lower: V_{IN} , 100 V / div., 4 s / div.



18 Conducted EMI

18.1 Test Set-up

LED metal heat sink is connected to ground. Unit with input ground wire connection is placed on top of LED metal heat sink. See below set-up picture.

18.2 Equipment and Load Used

1. Rohde and Schwarz ENV216 two line V-network.
2. Rohde and Schwarz ESRP EMI test receiver.
3. Hioki 3322 power hitester.
4. Chroma measurement test fixture.
5. 42 V LED load with input voltage set at 120 VAC and 230 VAC.

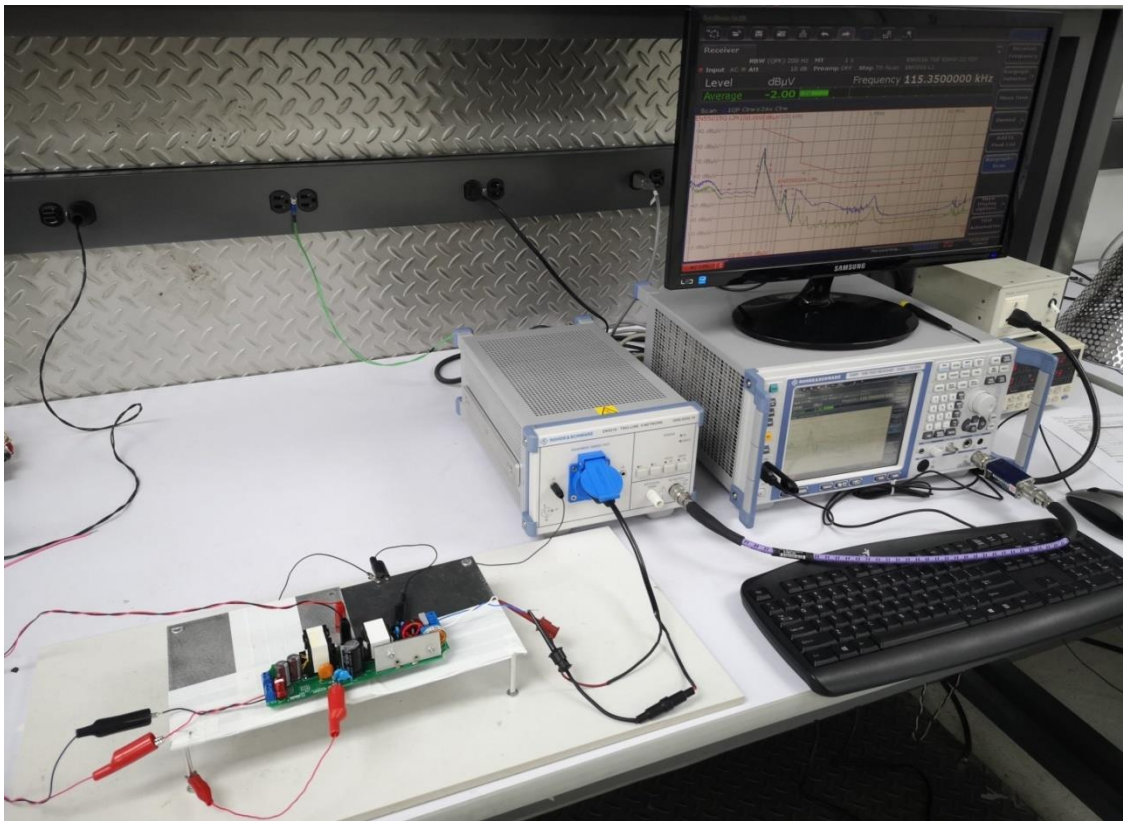

Figure 101 – Conducted EMI Test Set-up.

18.2.1 EMI Test Results

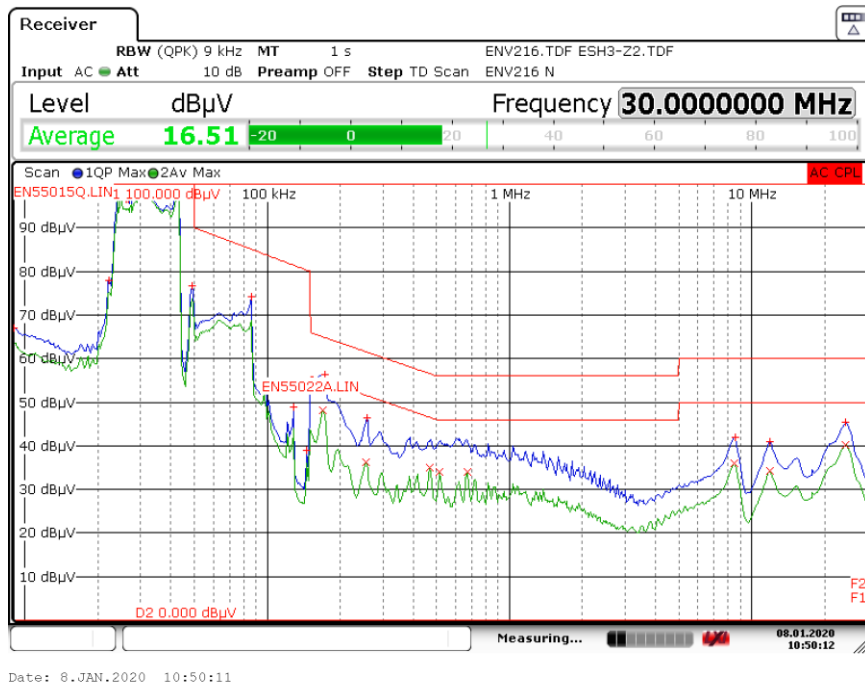

Figure 102 – Conducted EMI QP Scan at 42 V LED Load, 120 VAC, 60 Hz, and EN55015 B Limits.

Trace/Detector	Frequency	Level dBµV	DeltaLimit
2 Average	170.2500 kHz	48.06 N	-6.89 dB
1 Quasi Peak	172.5000 kHz	56.41 N	-8.43 dB
1 Quasi Peak	42.9000 kHz	101.31 N	-8.69 dB
2 Average	24.4775 MHz	40.24 N	-9.76 dB
1 Quasi Peak	24.8500 kHz	99.76 N	-10.24 dB
1 Quasi Peak	86.1500 kHz	74.24 L1	-10.81 dB
1 Quasi Peak	30.9500 kHz	98.97 N	-11.03 dB
1 Quasi Peak	24.1500 kHz	98.66 N	-11.34 dB
1 Quasi Peak	29.8000 kHz	98.37 N	-11.63 dB
2 Average	467.2500 kHz	34.92 N	-11.64 dB
1 Quasi Peak	29.4000 kHz	98.16 N	-11.84 dB
1 Quasi Peak	28.9500 kHz	97.96 N	-12.04 dB
1 Quasi Peak	28.5000 kHz	97.92 N	-12.08 dB
2 Average	516.7500 kHz	33.89 N	-12.11 dB

Figure 103 – Conducted EMI Data at 120 VAC, 42 V LED Load.



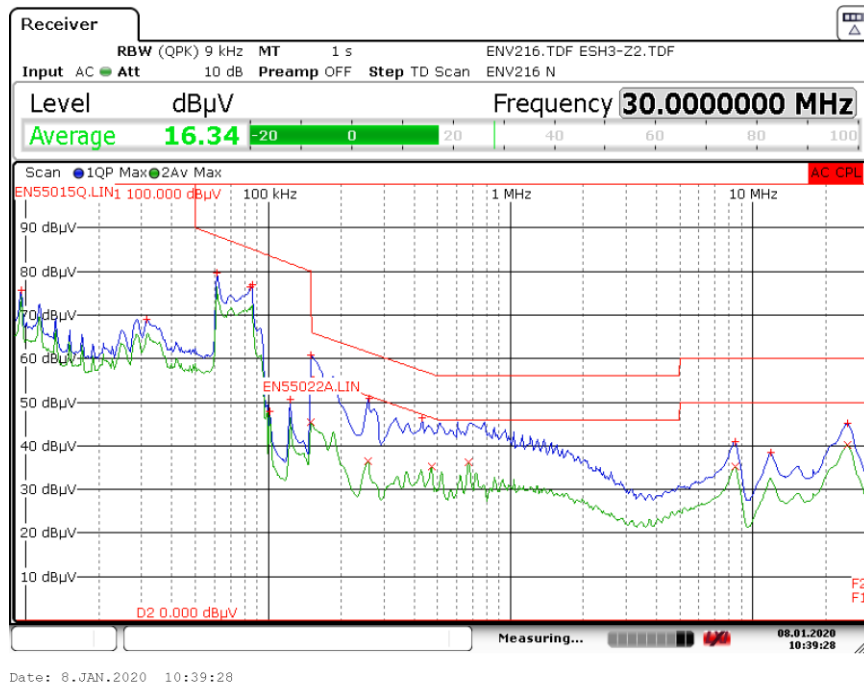

Figure 104 – Conducted EMI QP Scan at 42 V LED Load, 230 VAC, 60 Hz, and EN55015 B Limits.

Trace/Detector	Frequency	Level dBµV	DeltaLimit
1 Quasi Peak	150.0000 kHz	60.74 N	-5.26 dB
1 Quasi Peak	85.9500 kHz	76.93 N	-8.14 dB
1 Quasi Peak	61.5000 kHz	79.56 N	-8.56 dB
1 Quasi Peak	84.4000 kHz	76.31 N	-8.92 dB
2 Average	674.2500 kHz	36.17 N	-9.83 dB
2 Average	24.6395 MHz	40.15 N	-9.85 dB
2 Average	150.0000 kHz	45.45 L1	-10.55 dB
1 Quasi Peak	260.2500 kHz	50.83 N	-10.59 dB
1 Quasi Peak	433.5000 kHz	46.43 N	-10.76 dB
2 Average	471.7500 kHz	35.18 N	-11.30 dB
2 Average	8.4755 MHz	35.30 L1	-14.70 dB
1 Quasi Peak	24.6485 MHz	45.19 N	-14.81 dB
2 Average	258.0000 kHz	36.54 N	-14.96 dB
1 Quasi Peak	8.4755 MHz	40.94 L1	-19.06 dB

Figure 105 – Conducted EMI Data at 230 VAC, 42 V LED Load.

19 Line Surge

The unit was subjected to ± 2500 V, 100 kHz ring wave and ± 1000 V differential surge with 10 strikes at each condition. A test failure was defined as a non-recoverable interruption of output requiring repair or recycling of input voltage.

19.1 Differential Surge Test Results

Surge Level (V)	Input Voltage (VAC)	Injection Location	Injection Phase (°)	Test Result (Pass/Fail)
+1000	120	L to N	0	Pass
-1000	120	L to N	0	Pass
+1000	120	L to N	90	Pass
-1000	120	L to N	90	Pass
+1000	120	L to N	270	Pass
-1000	120	L to N	270	Pass
+1000	230	L to N	0	Pass
-1000	230	L to N	0	Pass
+1000	230	L to N	90	Pass
-1000	230	L to N	90	Pass
+1000	230	L to N	270	Pass
-1000	230	L to N	270	Pass

19.2 Ring Wave Test Results

Surge Level (V)	Input Voltage (VAC)	Injection Location	Injection Phase (°)	Test Result (Pass/Fail)
+2500	120	L to N	0	Pass
-2500	120	L to N	0	Pass
+2500	120	L to N	90	Pass
-2500	120	L to N	90	Pass
+2500	120	L to N	270	Pass
-2500	120	L to N	270	Pass
+2500	230	L to N	0	Pass
-2500	230	L to N	0	Pass
+2500	230	L to N	90	Pass
-2500	230	L to N	90	Pass
+2500	230	L to N	270	Pass
-2500	230	L to N	270	Pass

20 Brown-in/Brown-out Test

No abnormal overheating, current overshoot/undershoot was observed during and after 0.5 V / s and 1 V / s brown in and brown out test.

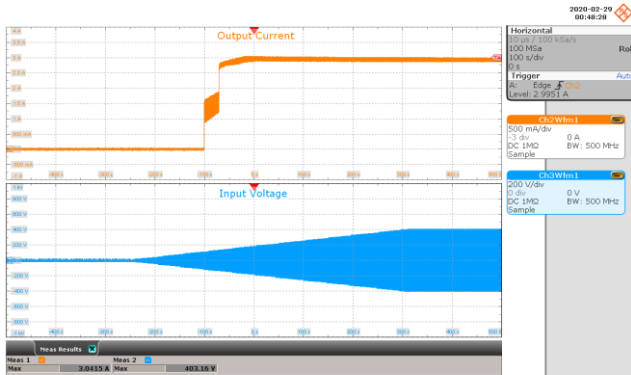

Figure 106 – Brown-in Test at 0.5 V / s.
 Ch1: I_{OUT} , 500 mA / div.
 Ch2: V_{IN} , 200 V / div.
 Time Scale: 100 s / div.

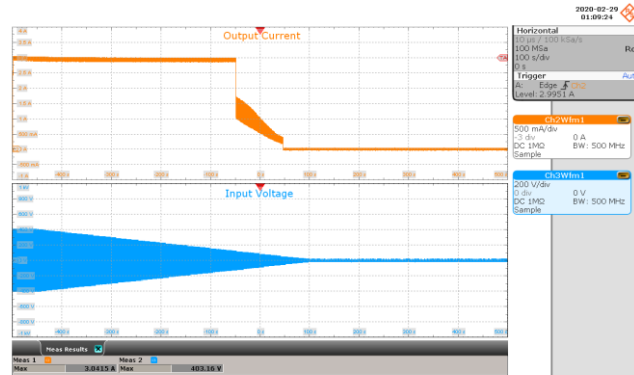

Figure 107 – Brown-out Test at 0.5 V / s
 Ch1: I_{OUT} , 500 mA / div.
 Ch2: V_{IN} , 200 V / div.
 Time Scale: 100 s / div.

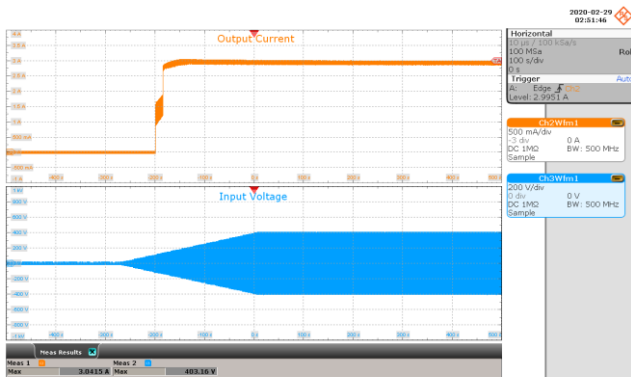

Figure 108 – Brown-in Test at 1 V / s.
 Ch1: I_{OUT} , 500 mA / div.
 Ch2: V_{IN} , 200 V / div.
 Time Scale: 100 s / div.

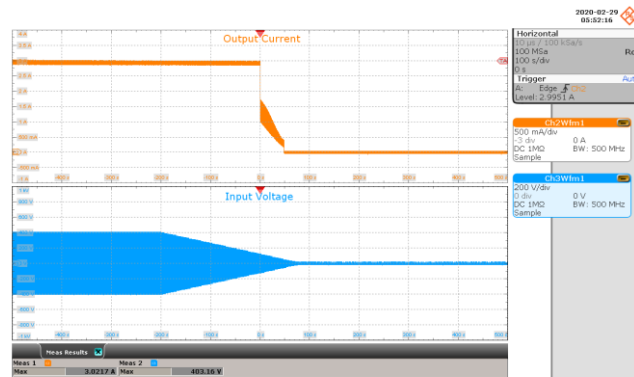

Figure 109 – Brown-out Test at 1 V / s.
 Ch1: I_{OUT} , 500 mA / div.
 Ch2: V_{IN} , 200 V / div.
 Time Scale: 100 s / div.

21 Revision History

Date	Author	Revision	Description and Changes	Reviewed
31-Mar-20	JB	1.0	Initial Release.	Apps & Mktg



For the latest updates, visit our website: www.power.com

Reference Designs are technical proposals concerning how to use Power Integrations' gate drivers in particular applications and/or with certain power modules. These proposals are "as is" and are not subject to any qualification process. The suitability, implementation and qualification are the sole responsibility of the end user. The statements, technical information and recommendations contained herein are believed to be accurate as of the date hereof. All parameters, numbers, values and other technical data included in the technical information were calculated and determined to our best knowledge in accordance with the relevant technical norms (if any). They may base on assumptions or operational conditions that do not necessarily apply in general. We exclude any representation or warranty, express or implied, in relation to the accuracy or completeness of the statements, technical information and recommendations contained herein. No responsibility is accepted for the accuracy or sufficiency of any of the statements, technical information, recommendations or opinions communicated and any liability for any direct, indirect or consequential loss or damage suffered by any person arising therefrom is expressly disclaimed.

Power Integrations reserves the right to make changes to its products at any time to improve reliability or manufacturability. Power Integrations does not assume any liability arising from the use of any device or circuit described herein. POWER INTEGRATIONS MAKES NO WARRANTY HEREIN AND SPECIFICALLY DISCLAIMS ALL WARRANTIES INCLUDING, WITHOUT LIMITATION, THE IMPLIED WARRANTIES OF MERCHANTABILITY, FITNESS FOR A PARTICULAR PURPOSE, AND NON-INFRINGEMENT OF THIRD PARTY RIGHTS.

Patent Information

The products and applications illustrated herein (including transformer construction and circuits' external to the products) may be covered by one or more U.S. and foreign patents, or potentially by pending U.S. and foreign patent applications assigned to Power Integrations. A complete list of Power Integrations' patents may be found at www.power.com. Power Integrations grants its customers a license under certain patent rights as set forth at <http://www.power.com/ip.htm>.

Power Integrations, the Power Integrations logo, CAPZero, ChiPhy, CHY, DPA-Switch, EcoSmart, E-Shield, eSIP, eSOP, HiperPLC, HiperPFS, HiperTFS, InnoSwitch, Innovation in Power Conversion, InSOP, LinkSwitch, LinkZero, LYTSwitch, SENZero, TinySwitch, TOPSwitch, PI, PI Expert, SCALE, SCALE-1, SCALE-2, SCALE-3 and SCALE-iDriver, are trademarks of Power Integrations, Inc. Other trademarks are property of their respective companies. ©2019, Power Integrations, Inc.

Power Integrations Worldwide Sales Support Locations**WORLD HEADQUARTERS**

5245 Hellyer Avenue
San Jose, CA 95138, USA.
Main: +1-408-414-9200
Customer Service:
Worldwide: +1-65-635-64480
Americas: +1-408-414-9621
e-mail: usasales@power.com

CHINA (SHANGHAI)

Rm 2410, Charity Plaza, No. 88,
North Caoxi Road,
Shanghai, PRC 200030
Phone: +86-21-6354-6323
e-mail: chinasales@power.com

CHINA (SHENZHEN)

17/F, Hivac Building, No. 2, Keji
Nan 8th Road, Nanshan District,
Shenzhen, China, 518057
Phone: +86-755-8672-8689
e-mail: chinasales@power.com

GERMANY (AC-DC/LED Sales)

Einsteinring 24
85609 Dornach/Aschheim
Germany
Tel: +49-89-5527-39100
e-mail: eurosales@power.com

GERMANY (Gate Driver Sales)

HellwegForum 1
59469 Ense
Germany
Tel: +49-2938-64-39990
e-mail: igbt-driver.sales@power.com

INDIA

#1, 14th Main Road
Vasanthanagar
Bangalore-560052
India
Phone: +91-80-4113-8020
e-mail: indiasales@power.com

ITALY

Via Milanese 20, 3rd. Fl.
20099 Sesto San Giovanni (MI) Italy
Phone: +39-024-550-8701
e-mail: eurosales@power.com

JAPAN

Yusen Shin-Yokohama 1-chome Bldg.
1-7-9, Shin-Yokohama, Kohoku-ku
Yokohama-shi,
Kanagawa 222-0033 Japan
Phone: +81-45-471-1021
e-mail: japansales@power.com

KOREA

RM 602, 6FL
Korea City Air Terminal B/D,
159-6
Samsung-Dong, Kangnam-Gu,
Seoul, 135-728 Korea
Phone: +82-2-2016-6610
e-mail: koreasales@power.com

SINGAPORE

51 Newton Road,
#19-01/05 Goldhill Plaza
Singapore, 308900
Phone: +65-6358-2160
e-mail: singaporesales@power.com

TAIWAN

5F, No. 318, Nei Hu Rd.,
Sec. 1
Nei Hu District
Taipei 11493, Taiwan R.O.C.
Phone: +886-2-2659-4570
e-mail: taiwansales@power.com

UK

Building 5, Suite 21
The Westbrook Centre
Milton Road
Cambridge
CB4 1YG
Phone: +44 (0) 7823-557484
e-mail: eurosales@power.com

